

# CYLINDER AND LOCK RANGE

—  
From well protected to super secure



# CONTENTS

---



## Intro

2-17



## Cylinders

18-127



## Multipoint locking systems

128-277



## Mortise Locks

278-567

## Introducing DORMA

2-17

## Reverse key systems

28-71

## Flat key systems

72-117

## Accessories

118-127

## Multipoint locking systems for escape routes

132-163

## Multipoint locking systems

164-277

## Locks for wide stile doors

284-489

## Locks for narrow stile doors

490-567

Prices and technical details are subject to change without notice.  
Gross prices in Euro without VAT.



## Appendix

568–571

### **Terms and conditions of business**

570–571

ARCHITECTURE IS OUR PASSION.  
DELIVERING PREMIUM ACCESS  
SOLUTIONS AND SERVICES IS OUR  
CALLING.

---



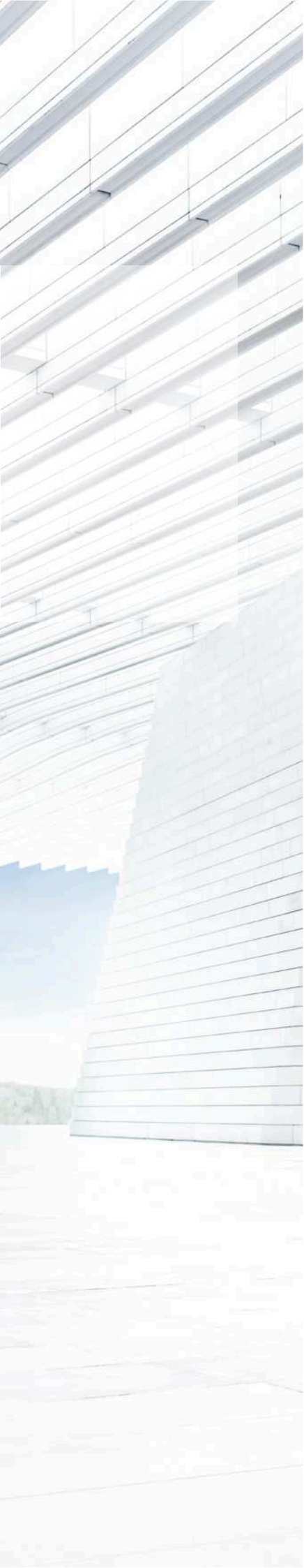

DORMA, one of the leading manufacturers for premium access solutions and services, is your trusted global partner for enabling better buildings.

### **Reliability**

Trust doesn't come instantly. When you work with us, we can offer you reliable access solutions based on over 100 years of experience.

### **Premium quality**

We at DORMA believe that the best solutions are based on people's needs. That's why we create products that are focused on real insights. Good quality is one thing. Premium quality is even better.

### **Innovations**

As one of the innovation leaders in our industry, we work every day on the solutions for tomorrow.

### **Design expertise**

We have design expertise for the perfect mix of aesthetic and functionality. We believe that good design needs to be both timeless and inspiring. With our passion for great architecture, we make good things even better.

### **Services**

This approach has enabled us to establish an outstanding portfolio of products for the full range of applications at and around the door. With services around the clock. And with availability around the world. We believe that it is the simple things that make most difference. We constantly re-examine our processes, ensuring they are fully aligned to deliver the greatest customer benefit. We are also making our products and services ever more accessible.

From architectural hardware to door closers, from operators to glass fittings and accessories, and from access control systems to locks and cylinders.

**Welcome to the world of DORMA.**



AS A RELIABLE PARTNER,  
WE SUPPORT OUR CUSTOMERS  
EVERY STEP OF THE WAY.

---

For us, a partnership is more than just a means to a transaction. We know that business is done by people. So our aim is to make our customers happy, both as businesses, but more importantly, as people.

DORMA offers unique capabilities in every phase of a building outfitting project – from planning and installation to regular maintenance. We regard reliable, individualized service provision as an integral part of the tailored package we offer each of our customers.

Product excellence, advice and service combine to create an ideally coordinated business portfolio. With uniformly high quality worldwide suited to practically every conceivable door and room situation.

WE ARE COMMITTED TO  
SUSTAINABLE DEVELOPMENT AS  
ONE OF OUR BUSINESS MAXIMS

---





—  
 INFRA West, Belgium  
 Architects: Crepain Binst Architecture  
 DORMA solutions: Automatic door systems and glass fittings and accessories



**Ecological**

We believe in environmental conservation and that it is crucial to continually improve and develop products with sustainability in mind. That is why we manufacture products from materials offering high recyclability, years of reliable functionality and minimal energy consumption rated.

**Economical**

We believe that sustainability should be an integral part of our design work, the way we operate our facilities, and our partnerships with suppliers. Consequently, we focus on e-commerce over printing, use green electricity in our various production sites and work with partners who are committed to sustainable development.

**Social**

We believe in a proactive approach to occupational health and safety to achieve continuous improvement and open stakeholder communication.



As an example of our success in this domain, we have issued an environmental product declaration (EPD) to ISO 14025 covering our TS 93 door closer system, our swing door operators ED 100/250, our automatic sliding door range ST FLEX and our Premium lever handle sets.

WE ARE A FAMILY-OWNED  
COMPANY WITH GERMAN ROOTS.  
GLOBALLY ALIGNED WITH AN  
INTERNATIONAL NETWORK.

---

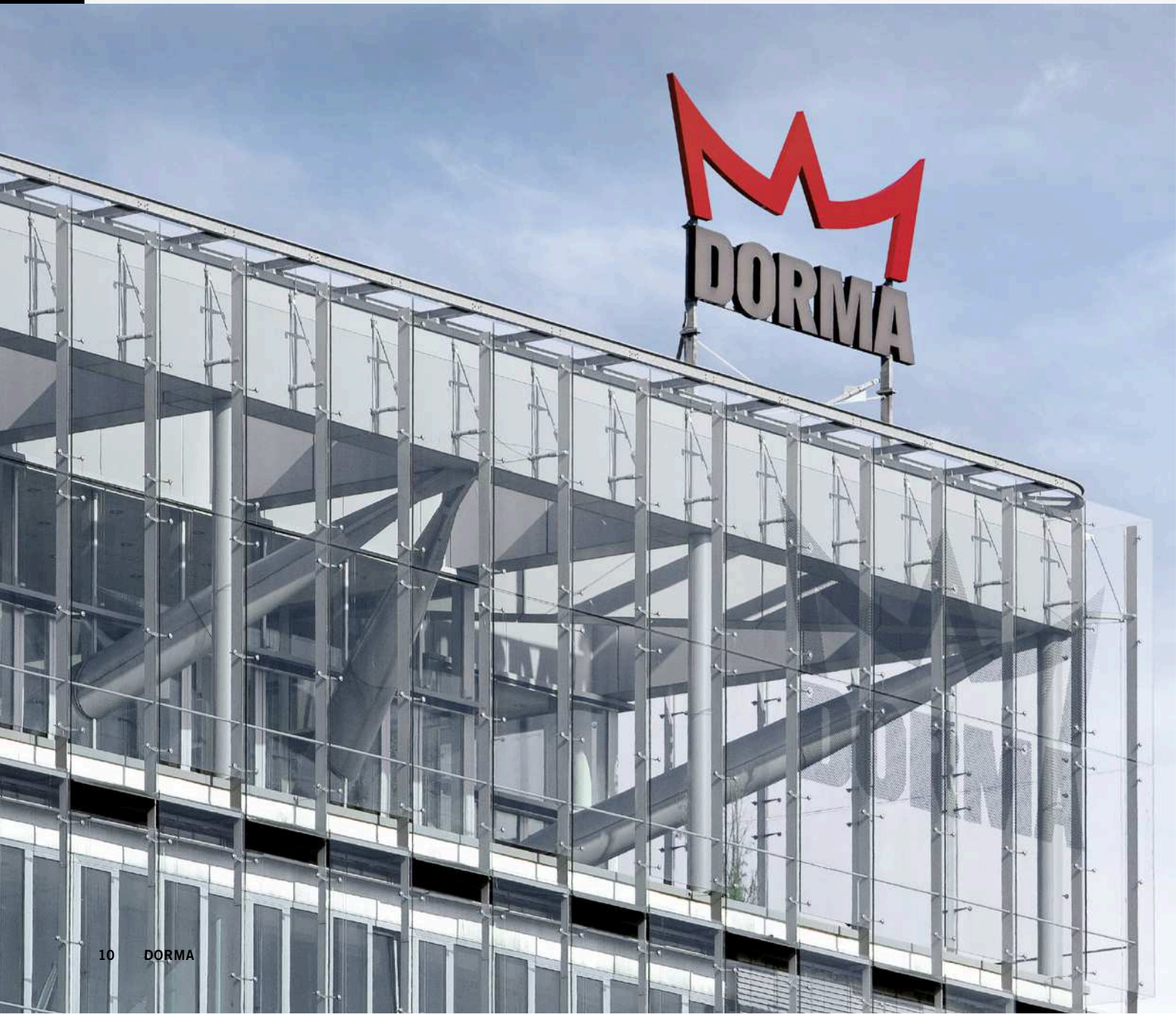



■ DORMA affiliated companies

#### **Headquarter**

Ennepetal, Germany

#### **Operational scale**

Worldwide, companies in 50 different countries

#### **Major production plants**

Europe, Singapore, Malaysia, China, North and South America

#### **Workforce**

Around 6,600 employees

The world is changing rapidly, and with it the demands being placed on our living spaces – developments that are driving us as a global enterprise to consistently provide our customers with the right responses in terms of design, protection and security. It is with this in mind that we have established our 2020 vision and growth strategy. In these, we have laid down a commitment to provide our customers, business partners and associates around the world with holistic solutions, marshalling our many years of sound expertise in the fields of door closers, automatic door systems, and attendance and access control systems.

In short: we intend to be the trusted global partner for premium access solutions and services around the world, enabling better buildings. In keeping with our brand claim:

**DORMA THE ACCESS**

WE MEET THE NEEDS OF OUR  
CUSTOMERS WITH TAILORED  
SOLUTIONS AND PERSONALIZED  
SERVICE

---



### Opening & closing



### Securing



### Dividing



### Services



“What’s the big picture?” This question is the starting point to all of our projects. We try to get into our clients shoes and plan projects in the most holistic way possible.

The results are access solutions that meet the specifications in full, properly tailored to the client's needs. Our global service network enables us to provide professional support during the entire life cycle of the products and systems supplied.

# OUR INVOLVEMENT IN PRESTIGIOUS PROJECTS WORLDWIDE.

---



—  
 Galaxy Soho, Beijing, China  
 Inauguration: October 2012  
 Architects: Zaha Hadid Architects  
 Photo: Hutton + Crow  
 DORMA solutions: Door closer  
 systems, glass fittings and accessories

—  
 Shanghai Tower  
 Inauguration: 2014 (planned)  
 Architects: Gensler Architects  
 Photo: Gensler Architects  
 DORMA solutions: Door closer  
 systems, automatic doors



—  
 Blue Planet Museum, Copenhagen,  
 Denmark  
 Inauguration: March 2011  
 Architects: 3XN  
 Photo: Adam Mørk  
 DORMA solutions: Door closer  
 systems and automatic swing doors



We provide access to numerous prestigious buildings around the world – a conspicuous expression of our global presence and our highly successful approach to forging business relationships. We open the doors to the best addresses worldwide. From hotels to airports, from banks to passenger liners.

# TRUST IN US FOR THAT COMFORTING FEELING OF RELIABLE SECURITY

---







It is that good feeling that you get when you enter a building. The instant certainty that you have the best possible protection and security around you. It's a feeling generated by the harmonious overall impression of the building, combined with intelligent architectural hardware.

DORMA cylinders and locks are important contributory factors in this domain. They offer exceptional lock technology married to materials of quality. They reliably secure, function with precision and durability, and blend in with their surroundings.

The DORMA product range offers a wide selection of individual solutions. For offices, for hotels, for schools and for the home – in short, wherever exacting security standards need to combine with simple convenience and enhanced ease of use.

This cylinder and lock portfolio extends the DORMA range, underlining our claim to the position of trusted partner for holistic access solutions.



SECURITY WITH  
PREMIUM ACCESS SOLUTIONS  
& SERVICES

# MULTIPOINT LOCKING SYSTEMS

---

164-277

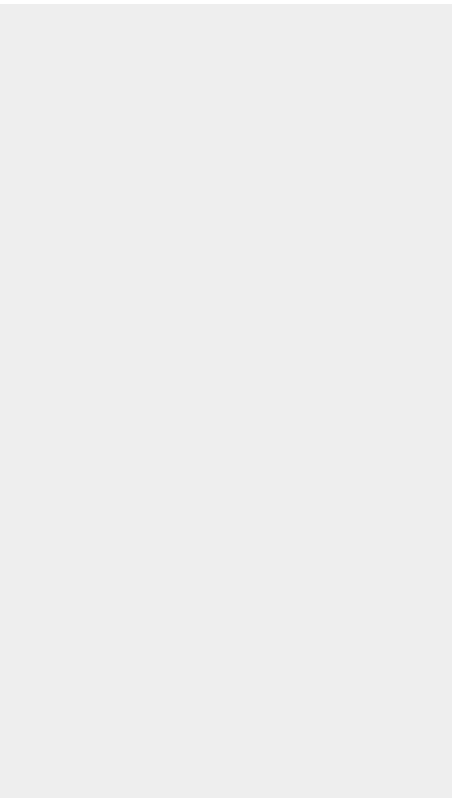

# NO-ONE GETS BY YOU GUYS

—



Well, there are three of us!



# DELIVERING MULTIPOINT SECURITY

## 810 series multipoint locking systems

DORMA's 810 series of multipoint locking systems offers follower-to-keyway centers of 85 and 92 mm, making them ideal for a wide range of applications. Operated by europrofile cylinders, these locks feature smooth-action chamfered deadbolts in the top and bottom lock cases, ensuring a secure keeper fit in the engaged location. With these specially developed chamfered bolts combined with the latest range of extrusion profiles, doors equipped with this system can offer excellent weather sealing for thermal insulation and energy economy.

### Plus points

- **Solid:** Hardened deadbolts available on request for maximum drill and cut resistance.
- **Compatible:** The lock case has a width of 15 mm, making it suitable for a wide range of door situations and frame materials.
- **Tight:** The lock case is closed all round, thus preventing swarf and chips from the machining operations entering the mechanism. The lock features a wheel-cam plug for extra protection in the absence of a cylinder.
- **Smooth:** Effortless operation achieved thanks to the easy gear response to key rotation.
- **Versatile:** The 810 series comes with a range of accessories offering further options including a latch, roller or blanking cap for deadlock-only action – making stocking and order handling particularly hassle-free.

### Tested and verified

- **Approval certification:** Compliant with prEN 15685
- **Sturdy:** Resistant to lateral thrust forces in excess of 1,000 kg and a front load of more than 600 kg.
- **Resilient:** Corrosion resistance proven over more than 240 hours of saline exposure.
- **Durable:** Proven with over 200,000 opening and closing cycles under a 120 N load.
- **Registration:** Series 810 multipoint locking systems –  
Models 1100000002705 – 1100000002728  
1100000002633 – 1100000002680

3 X 8 A 0 G 6 0 3



## 830 series multipoint locking systems

This new range of DORMA locks includes three user-selectable functions. The 830 series can be combined with an external fixed knob or a pull handle, while inclusion of a classic lever handle will also give emergency unlocking.

- **Automatic locking:** The 830 series offers automatic locking of the latch bolt and deadbolts as the door engages with the jamb. The selector provided within the forend can be switched at any time. The deadbolt only engages once the latch bolt has penetrated the striking plate to a depth of at least 3 mm. With this feature, the latch bolt aligns the door leaf perfectly to the jamb, ensuring that the deadbolt can engage smoothly and securely.
- **External opening:** A single turn of the key unlocks the deadbolts, with a further quarter turn disengaging the latch bolt.
- **Internal opening:** Once again, a single turn of the key is sufficient to unlock the deadbolts, with a further quarter turn disengaging the latch bolt. Lever handle rotation of 45° will disengage both the deadbolts and the latch bolt.
- **High-security mechanism:** A single turn of the key in the locking direction prevents lever handle operation from the inside, while turning the key in the opposite direction re-enables it. This security feature is only available once the deadbolt has been completely engaged, thus preventing inadvertent activation. This also ensures that automatic deadbolt locking is fully completed, even if a connecting rod has been blocked. Hence, if one of the deadbolts is attacked, all the others remain engaged. The lever block prevents opening from the inside (or indeed from the outside if the door has been broken through), thus providing additional security while also ensuring easier, safer exit control.

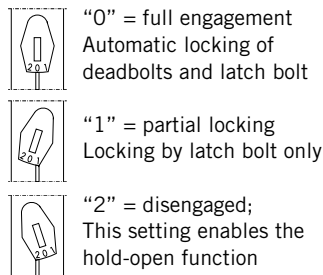

3 X 8 A 0 G 7 3 0

### Tested and verified

- **Approval certification:** Compliant with prEN 15685.
- **Sturdy:** Resistant to lateral thrust forces in excess of 1,000 kg and a front load of more than 600 kg.
- **Resilient:** Corrosion resistance proven over more than 240 hours of saline exposure.
- **Durability:** Proven with over 200,000 opening and closing cycles under a 120 N load.
- **Registration:** Series 830 multipoint locking systems –  
Models 1100000003225 – 1100000003236  
1100000002817 – 1100000002820  
1100000002785 – 1100000002792  
1100000002809 – 1100000002812



## 840 series multipoint locking systems

The new 840 series combined with the DORMA range of cylinders ensures an especially high level of security.

- Steel lock case, closed on all sides
- Reinforced deadbolts, surface carbo-nitrided for exceptional drill and cut protection
- Deadbolt system for maximum anti-crack protection (Figs. 1, 2, 3)
- External attack of one deadbolt leaves the other two unaffected. Thus each deadbolt has to be individually attacked.

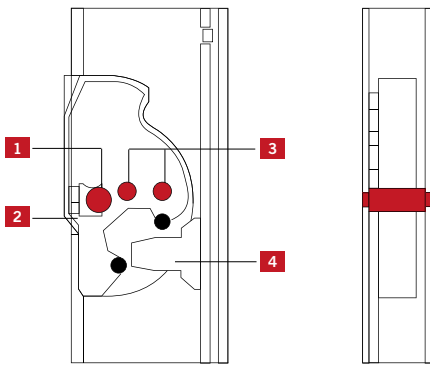

- 1** Deadbolt pivot pin
- 2** Rated breaking point
- 3** Security pins
- 4** Torque transfer and deadbolt blocking rod

Disengaged lock

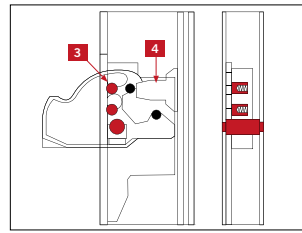

1) Engaged lock. Blocking ensured by torque transmission and deadbolt blocking rod. This opposes the deadbolt and secures it against the rear wall of the lock case. The security pins are non-operational.

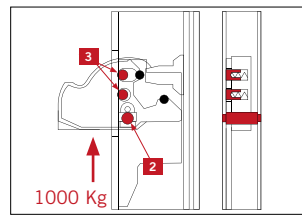

2) An upward force equivalent to 1 metric ton causes rated breaking point "2" to yield. This results in the security pins locating in the locking pockets within the plate integrated in the lock case. The deadbolt and case are thus rendered rigid.

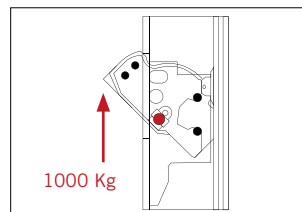

3) Deadbolt retraction back into the lock case is prevented by the relocation of its pivot point, causing interference with the forend.



### Tested and verified

- **Approval certification:** Compliant with prEN 15685 (three-point locking models)
- **Sturdy:** Resistant to lateral thrust forces in excess of 1,000 kg and a front load of more than 600 kg.
- **Resilient:** Corrosion resistance proven over more than 240 hours of saline exposure.
- **Durable:** Proven with over 200,000 opening and closing cycles under a 120 N load.
- **Registration:** Series 840 multipoint locking systems –  
 Models 110000002901 – 110000002940  
 110000002837 – 110000002856  
 110000002860

3 X 8 A 0 G 7 3 0

# ELECTROMECHANICAL MULTIPOINT LOCK

## 820 series

- Automatic locking of latch, 3 deadbolts and rotating hook bolts; 12V D.C.
- Central lock; center distance 92 mm; for operation with europrofile cylinder
- Right or left latch, non reversible
- Deadbolts and latch operated by key, handle or motor
- Throw: 27 mm with anti-drill and anti-cut cover plates in carbo-nitrided steel
- Connection cable, 2 nylon end blocks for U-version
- Accessories to be ordered separately:
- Striking plates for U-forend:
- Mechanical strikers 1100000002827-1100000002828
- Striking plates for flat forend: Mechanical striker 1100000002825-1100000002826

- A** Automatic locking
- L** Latch locking
- H** Rotating hook bolt
- P** 3-point locking
- Stainless steel

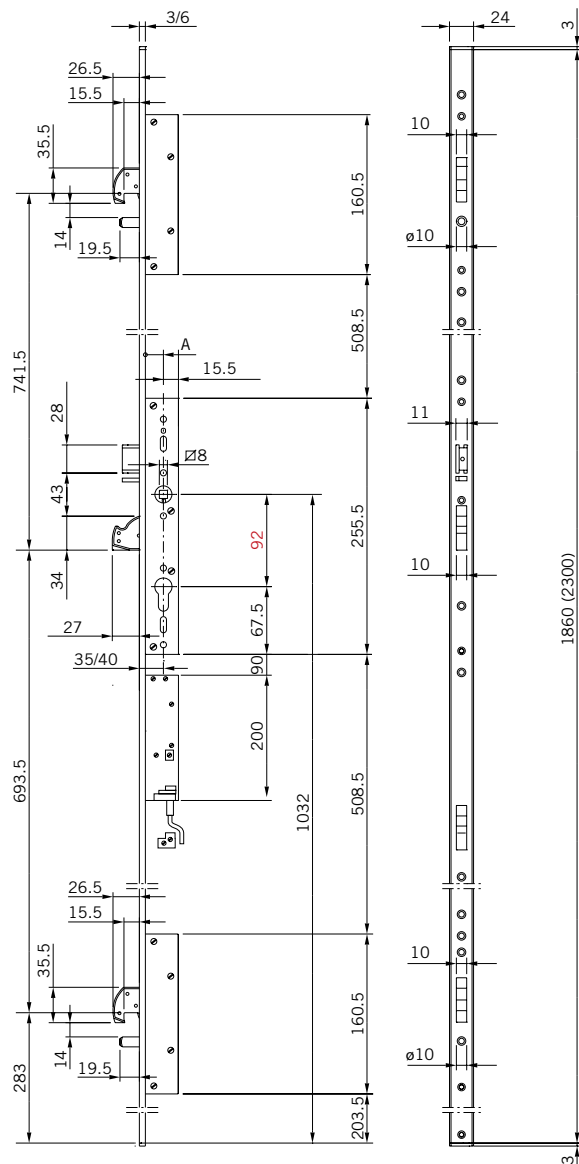



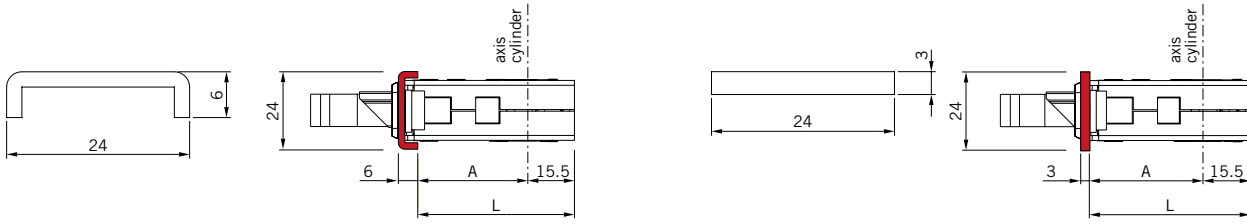

Stainless steel

Backset mm	Forend mm	Ld	Order No.	EAN	Handed	Packaging Unit	Gross Price per piece EURO
35	U-forend 6 mm		1100000002785	4021226945919	RH	1	
40	U-forend 6 mm		1100000002786	4021226945933	RH	1	
35	U-forend 6 mm		1100000002787	4021226945957	LH	1	
40	U-forend 6 mm		1100000002788	4021226945971	LH	1	
35	Flat forend 3 mm		1100000002789	4021226945995	RH	1	
40	Flat forend 3 mm		1100000002790	4021226946015	RH	1	
35	Flat forend 3 mm		1100000002791	4021226946039	LH	1	
40	Flat forend 3 mm		1100000002792	4021226946053	LH	1	

# ELECTROMECHANICAL MULTIPOINT LOCK

820 series – for round profile cylinder

- Swiss version
- Automatic locking of latch, 3 deadbolts and rotating hook bolts; 12V D.C.
- Central lock; center distance 94 mm; for operation with round profile cylinder
- Right or left latch, non reversible
- Deadbolts and latch operated by key, handle or motor
- Throw: 27 mm with anti-drill and anti-cut cover plates in carbo-nitrided steel
- Connection cable, 2 nylon end blocks for U-version
- Accessories to be ordered separately:
- Striking plates for U-forend:
- Mechanical strikers 1100000002827-1100000002828

- A** Automatic locking
- L** Latch locking
- H** Rotating hook bolt
- P** 3-point locking
- Stainless steel

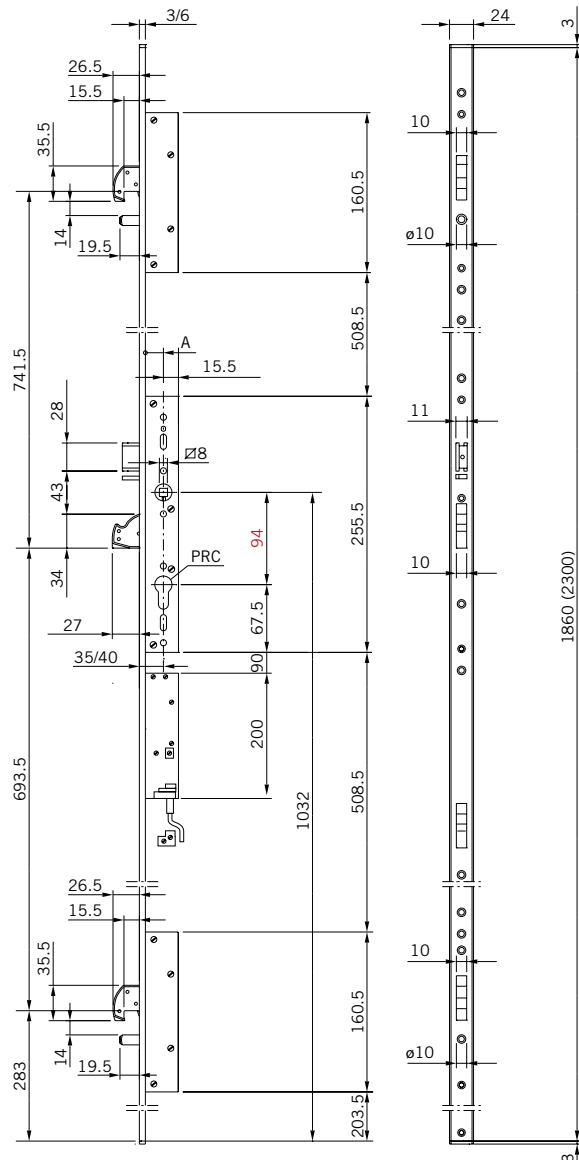

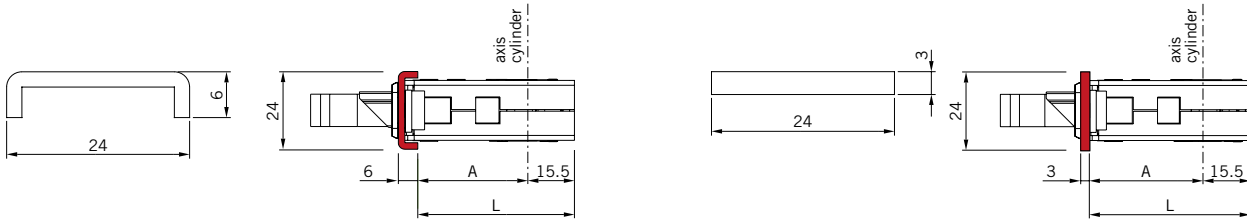

Stainless steel

Backset mm	Forend mm	Ld	Order No.	EAN	Handed	Packaging Unit	Gross Price per piece EURO
40	U-forend 6 mm		1100000002809	4021226946299	RH	1	
40	U-forend 6 mm		1100000002810	4021226946312	LH	1	
40	Flat forend 3 mm		1100000002811	4021226946336	RH	1	
40	Flat forend 3 mm		1100000002812	4021226946350	LH	1	

# ACCESSORIES

## Power supply

- Power supply - 230V A.C. - 12V D.C. - 3A



Order No.	EAN	Packaging Unit	Minimal Order	Gross Price per piece EURO
1100000002793	4021226946077	1		

## External soft cable tube

- L=300 mm



Order No.	EAN	Packaging Unit	Minimal Order	Gross Price per piece EURO
1100000002794	4021226946091	1		

## Built-in soft cable tube

- L=300 mm



Order No.	EAN	Packaging Unit	Minimal Order	Gross Price per piece EURO
1100000002795	4021226946114	1		



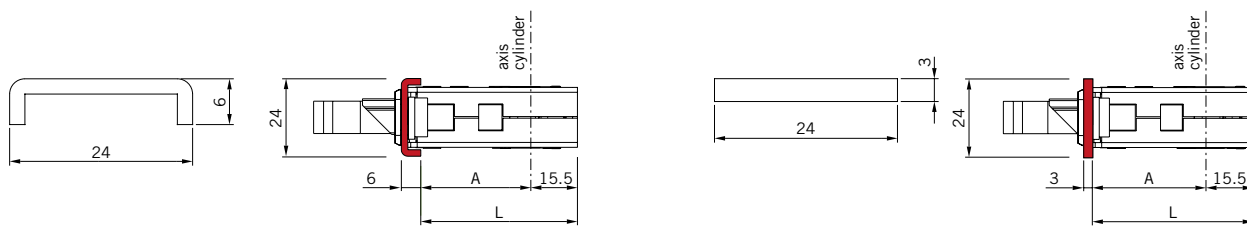

Stainless steel

Backset mm	Forend mm	Ld	Order No.	EAN	Handed	Packaging Unit	Gross Price per piece EURO
35	U-forend 6 mm		1100000003225	4021226954577	RH	1	
40	U-forend 6 mm		1100000003226	4021226954591	RH	1	
35	U-forend 6 mm		1100000003227	4021226954614	LH	1	
40	U-forend 6 mm		1100000003228	4021226954638	LH	1	
35	U-forend 6 mm		1100000003229	4021226954652	RH	1	
40	U-forend 6 mm		1100000003230	4021226954676	RH	1	
35	U-forend 6 mm		1100000003231	4021226954690	LH	1	
40	U-forend 6 mm		1100000003232	4021226954713	LH	1	
35	Flat forend 3 mm		1100000003233	4021226954737	RH	1	
40	Flat forend 3 mm		1100000003234	4021226954751	RH	1	
35	Flat forend 3 mm		1100000003235	4021226954775	LH	1	
40	Flat forend 3 mm		1100000003236	4021226954799	LH	1	



**MULTIPOINT LOCK 830 SERIES – FOR ROUND PROFILE CYLINDER MULTIPOINT LOCK – AUTOMATIC LOCKING FUNCTION**

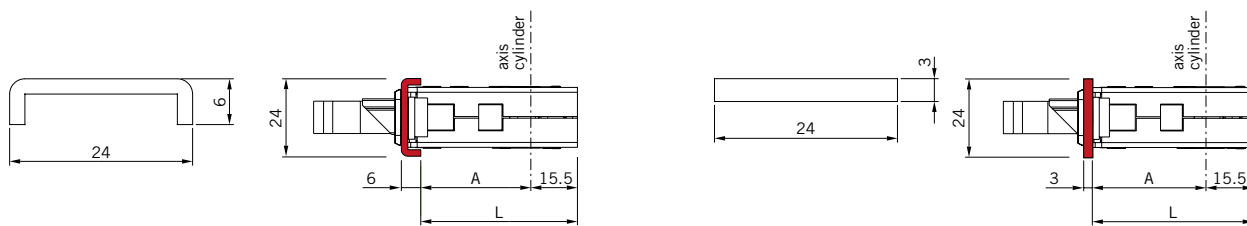

**Stainless steel**

Backset mm	Forend mm	Ld	Order No.	EAN	Handed	Packaging Unit	Gross Price per piece EURO
40	U-forend 6 mm		1100000002817	4021226946459	RH	1	
40	U-forend 6 mm		1100000002818	4021226946473	LH	1	
40	Flat forend 3 mm		1100000002819	4021226946497	RH	1	
40	Flat forend 3 mm		1100000002820	4021226946510	LH	1	



# STRIKING PLATES

Adjustable closed striking plate for 820, 821, 830 and 831 series

- With mechanical striker

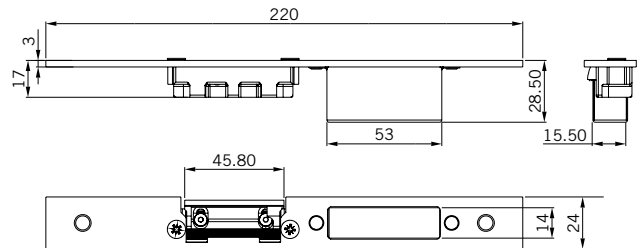

■ Stainless steel

Feature	Order No.	EAN	Packaging Unit	Minimal Order	Gross Price per piece EURO
Flat forend 24 x 3 x 220 mm left handed	1100000002825	4021226946619	10		
Flat forend 24 x 3 x 220 mm right handed	1100000002826	4021226946633	10		

Adjustable closed striking plate for 820, 821, 830 and 831 series

- With mechanical striker

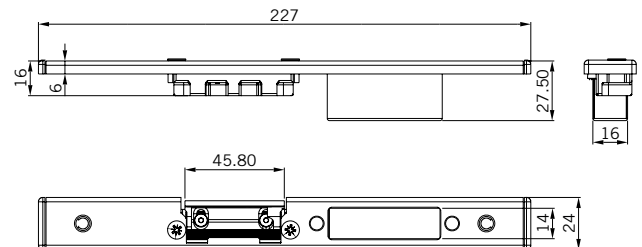

■ Stainless steel

Feature	Order No.	EAN	Packaging Unit	Minimal Order	Gross Price per piece EURO
U-forend 24 x 6 x 220 mm left handed	1100000002827	4021226946657	10		
U-forend 24 x 6 x 220 mm right handed	1100000002828	4021226946671	10		

Adjustable closed striking plate for 830 and 831 series

- With electric striker, unlatching with 12V A.C. supply; 15W electric pulse only

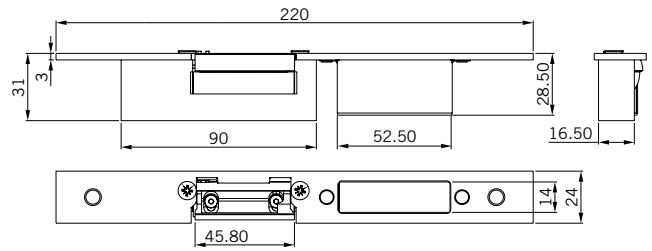

Stainless steel

Feature	Order No.	EAN	Packaging Unit	Minimal Order	Gross Price per piece EURO
Flat forend 24 x 3 x 220 mm left handed	1100000002829	4021226946695	10		
Flat forend 24 x 3 x 220 mm right handed	1100000002830	4021226946718	10		

Adjustable closed striking plate for 830 and 831 series

- With electric striker, unlatching with 12V A.C. supply; 15W electric pulse only

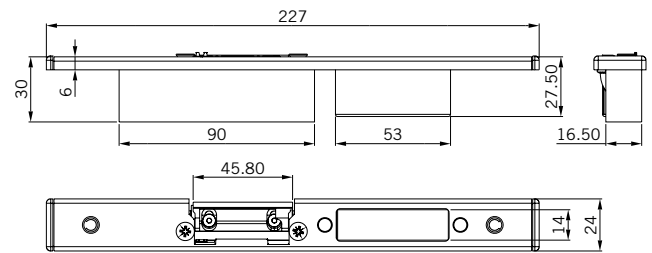

Stainless steel

Feature	Order No.	EAN	Packaging Unit	Minimal Order	Gross Price per piece EURO
U-forend 24 x 6 x 220 mm left handed	1100000002831	4021226946732	10		
U-forend 24 x 6 x 220 mm right handed	1100000002832	4021226946756	10		

Pair of adjustable closed striking plates for top/bottom hook bolts for 840 series

- To be used with central striking plates 1100000002825-1100000002826-1100000002829-1100000002830-1100000002981-1100000002982

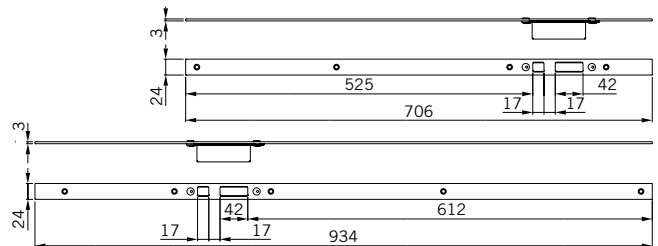

Stainless steel

Feature	Order No.	EAN	Packaging Unit	Minimal Order	Gross Price per piece EURO
Flat forend 24 x 3 x 1860 mm	1100000002833	4021226946770	10		

Pair of adjustable closed striking plates for top/bottom hook bolts for 840 series

- To be used with central striking plates 1100000002827-1100000002828-1100000002831-1100000002832-1100000002983-1100000002984

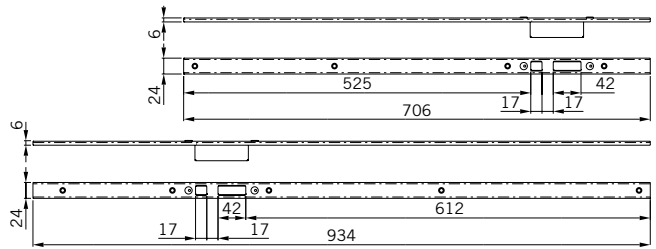

■ Stainless steel

Feature	Order No.	EAN	Packaging Unit	Minimal Order	Gross Price per piece EURO
U-forend 24 x 3 x 1860 mm	1100000002834	4021226946794	10		

Adjustable closed striking plate for hook bolts for 840 series

- To be used with striking plates 1100000002825-1100000002826-1100000002829-1100000002830-1100000002981-1100000002982

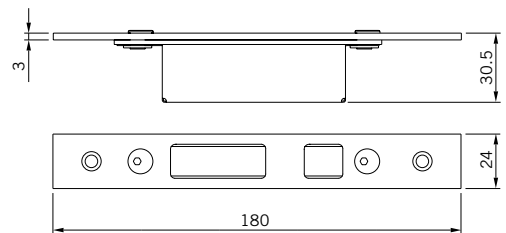

■ Stainless steel

Feature	Order No.	EAN	Packaging Unit	Minimal Order	Gross Price per piece EURO
Flat forend 24 x 3 x 180 mm	1100000002835	4021226946817	10		

Adjustable closed striking plate for hook bolts for 840 series

- To be used with striking plates 1100000002827-1100000002828-1100000002831-1100000002832-1100000002983-1100000002984

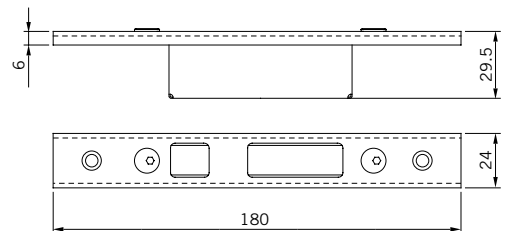

■ Stainless steel

Feature	Order No.	EAN	Packaging Unit	Minimal Order	Gross Price per piece EURO
U-forend 24 x 6 x 180 mm	1100000002836	4021226946831	10		



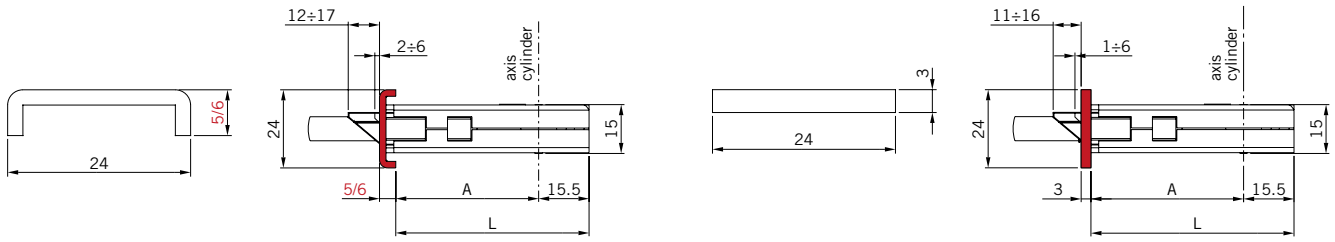

**Stainless steel**

Backset mm	Forend mm	Ld	Order No.	EAN	Handed	Packaging Unit	Gross Price per piece EURO
25	U-forend 6 mm		1100000002585	4021226941911	non	1	
30	U-forend 6 mm		1100000002586	4021226941935	non	1	
35	U-forend 6 mm		1100000002587	4021226941959	non	1	
40	U-forend 6 mm		1100000002588	4021226941973	non	1	
45	U-forend 6 mm		1100000002589	4021226941997	non	1	
50	U-forend 6 mm		1100000002590	4021226942017	non	1	
55	U-forend 6 mm		1100000002591	4021226942031	non	1	
60	U-forend 6 mm		1100000002592	4021226942055	non	1	
25	U-forend 5 mm		1100000002593	4021226942079	non	1	
30	U-forend 5 mm		1100000002594	4021226942093	non	1	
35	U-forend 5 mm		1100000002595	4021226942116	non	1	
40	U-forend 5 mm		1100000002596	4021226942130	non	1	
45	U-forend 5 mm		1100000002597	4021226942154	non	1	
50	U-forend 5 mm		1100000002598	4021226942178	non	1	
55	U-forend 5 mm		1100000002599	4021226942192	non	1	
60	U-forend 5 mm		1100000002600	4021226942215	non	1	
25	Flat forend 3 mm		1100000002601	4021226942239	non	1	
30	Flat forend 3 mm		1100000002602	4021226942253	non	1	
35	Flat forend 3 mm		1100000002603	4021226942277	non	1	
40	Flat forend 3 mm		1100000002604	4021226942291	non	1	
45	Flat forend 3 mm		1100000002605	4021226942314	non	1	
50	Flat forend 3 mm		1100000002606	4021226942338	non	1	
55	Flat forend 3 mm		1100000002607	4021226942352	non	1	
60	Flat forend 3 mm		1100000002608	4021226942376	non	1	

■ Black-painted steel							
Backset mm	Forend mm	Ld	Order No.	EAN	Handed	Packaging Unit	Gross Price per piece EURO
25	U-forend 6 mm		1100000002609	4021226942390	non	1	
30	U-forend 6 mm		1100000002610	4021226942413	non	1	
35	U-forend 6 mm		1100000002611	4021226942437	non	1	
40	U-forend 6 mm		1100000002612	4021226942451	non	1	
45	U-forend 6 mm		1100000002613	4021226942475	non	1	
50	U-forend 6 mm		1100000002614	4021226942499	non	1	
55	U-forend 6 mm		1100000002615	4021226942512	non	1	
60	U-forend 6 mm		1100000002616	4021226942536	non	1	
25	U-forend 5 mm		1100000002617	4021226942550	non	1	
30	U-forend 5 mm		1100000002618	4021226942574	non	1	
35	U-forend 5 mm		1100000002619	4021226942598	non	1	
40	U-forend 5 mm		1100000002620	4021226942611	non	1	
45	U-forend 5 mm		1100000002621	4021226942635	non	1	
50	U-forend 5 mm		1100000002622	4021226942659	non	1	
55	U-forend 5 mm		1100000002623	4021226942673	non	1	
60	U-forend 5 mm		1100000002624	4021226942697	non	1	
25	Flat forend 3 mm		1100000002625	4021226942710	non	1	
30	Flat forend 3 mm		1100000002626	4021226942734	non	1	
35	Flat forend 3 mm		1100000002627	4021226942758	non	1	
40	Flat forend 3 mm		1100000002628	4021226942772	non	1	
45	Flat forend 3 mm		1100000002629	4021226942796	non	1	
50	Flat forend 3 mm		1100000002630	4021226942819	non	1	
55	Flat forend 3 mm		1100000002631	4021226942833	non	1	
60	Flat forend 3 mm		1100000002632	4021226942857	non	1	

# MULTIPOINT HOOK LOCK 92 MM DISTANCE

## 810 series

- Lateral locking: rotating hook bolts
- Central lock; center distance 92 mm; for operation with europrofile cylinder
- Throw: 20 mm; Follower: 8 mm
- The latch can be replaced by roller latch or cap
- The lock is equipped with a wheel-cam stopping device if the cylinder is not fitted inside the lock case
- Accessories to be ordered separately:
  - Roller for central lock 1100000002760
  - Cap for deadbolt only versions 1100000002761

- R** Reversible latch bolt
- H** Rotating hook bolt
- Stainless steel

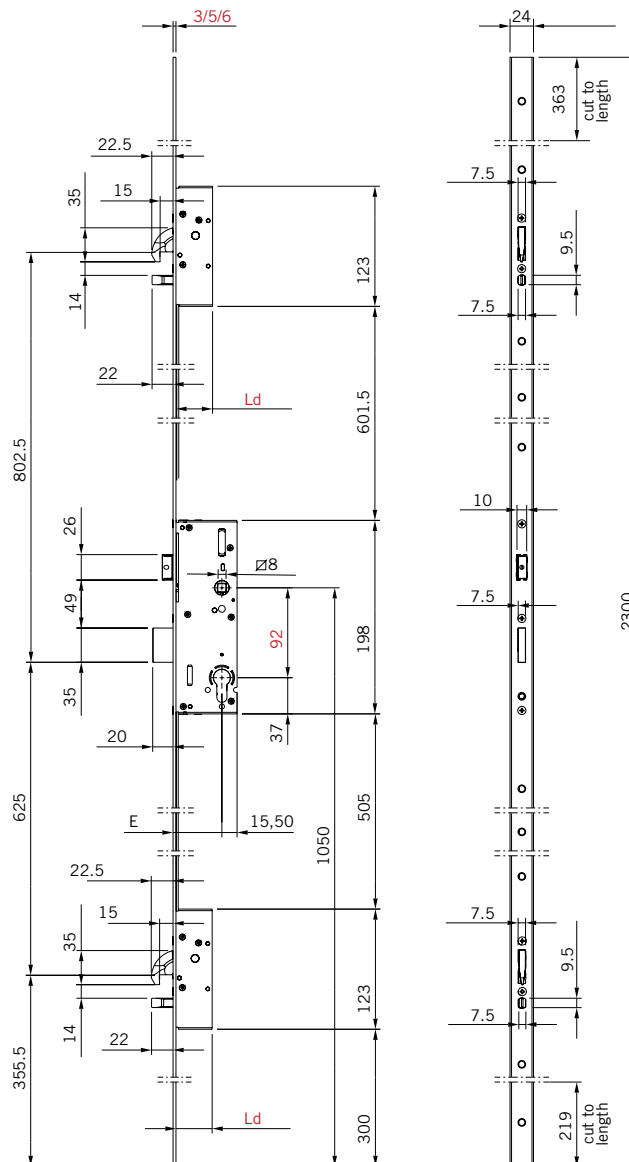

**MULTIPOINT LOCK 810 SERIES MULTIPOINT HOOK LOCK 92 MM DISTANCE**

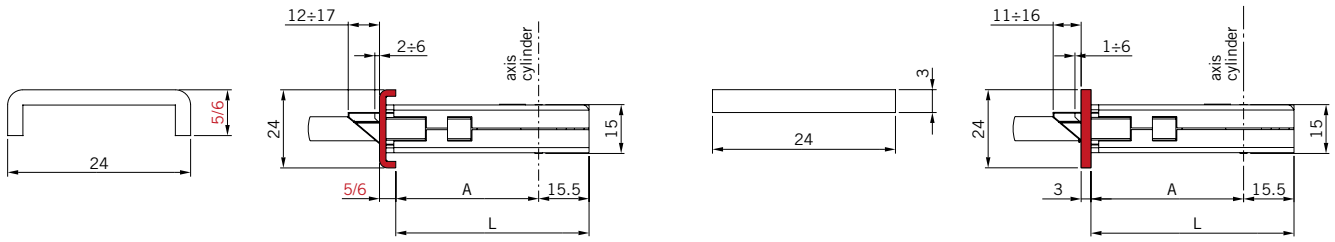

**Stainless steel**

Backset mm	Forend mm	Ld	Order No.	EAN	Handed	Packaging Unit	Gross Price per piece EURO
25	U-forend 6 mm		1100000002681	4021226943830	non	1	
30	U-forend 6 mm		1100000002682	4021226943854	non	1	
35	U-forend 6 mm		1100000002683	4021226943878	non	1	
40	U-forend 6 mm		1100000002684	4021226943892	non	1	
45	U-forend 6 mm		1100000002685	4021226943915	non	1	
50	U-forend 6 mm		1100000002686	4021226943939	non	1	
55	U-forend 6 mm		1100000002687	4021226943953	non	1	
60	U-forend 6 mm		1100000002688	4021226943977	non	1	
25	U-forend 5 mm		1100000002689	4021226943991	non	1	
30	U-forend 5 mm		1100000002690	4021226944011	non	1	
35	U-forend 5 mm		1100000002691	4021226944035	non	1	
40	U-forend 5 mm		1100000002692	4021226944059	non	1	
45	U-forend 5 mm		1100000002693	4021226944073	non	1	
50	U-forend 5 mm		1100000002694	4021226944097	non	1	
55	U-forend 5 mm		1100000002695	4021226944110	non	1	
60	U-forend 5 mm		1100000002696	4021226944134	non	1	
25	Flat forend 3 mm		1100000002697	4021226944158	non	1	
30	Flat forend 3 mm		1100000002698	4021226944172	non	1	
35	Flat forend 3 mm		1100000002699	4021226944196	non	1	
40	Flat forend 3 mm		1100000002700	4021226944219	non	1	
45	Flat forend 3 mm		1100000002701	4021226944233	non	1	
50	Flat forend 3 mm		1100000002702	4021226944257	non	1	
55	Flat forend 3 mm		1100000002703	4021226944271	non	1	
60	Flat forend 3 mm		1100000002704	4021226944295	non	1	



# MULTIPOINT DEADBOLT LOCK 85 MM DISTANCE

## 810 series

- Lateral locking: sliding deadbolts
- Central lock; center distance 85 mm; for operation with europrofile cylinder
- Throw: 20 mm; Follower: 8 mm
- The latch can be replaced by roller or cap
- The lock is equipped with a wheel-cam stopping device if the cylinder is not fitted inside the lock case
- Accessories to be ordered separately:
  - Roller for central lock 1100000002760
  - Cap for deadbolt only versions 1100000002761

- R** Reversible latch bolt
- Stainless steel
- Black-painted steel

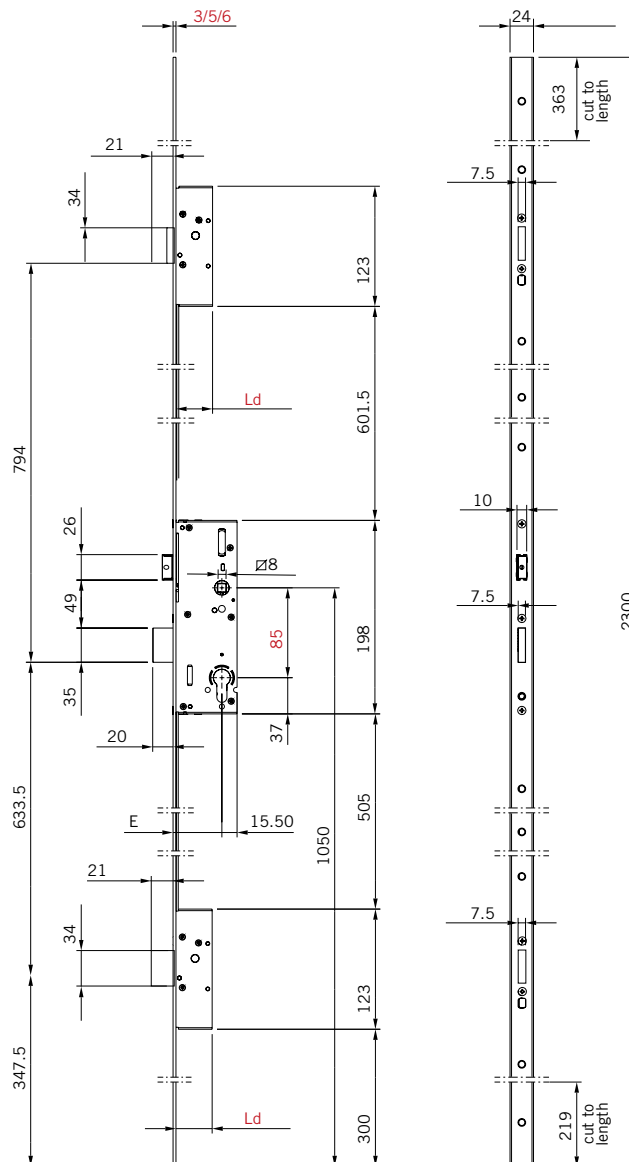

MULTIPOINT LOCK 810 SERIES MULTIPOINT DEADBOLT LOCK 85 MM DISTANCE

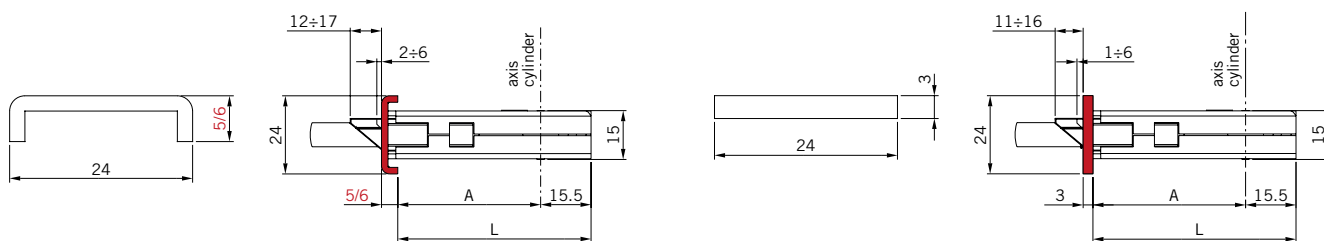

Stainless steel

Backset mm	Forend mm	Ld	Order No.	EAN	Handed	Packaging Unit	Gross Price per piece EURO
25	U-forend 6 mm		1100000002633	4021226942871	non	1	
30	U-forend 6 mm		1100000002634	4021226942895	non	1	
35	U-forend 6 mm		1100000002635	4021226942918	non	1	
40	U-forend 6 mm		1100000002636	4021226942932	non	1	
45	U-forend 6 mm		1100000002637	4021226942956	non	1	
50	U-forend 6 mm		1100000002638	4021226942970	non	1	
55	U-forend 6 mm		1100000002639	4021226942994	non	1	
60	U-forend 6 mm		1100000002640	4021226943014	non	1	
25	U-forend 5 mm		1100000002641	4021226943038	non	1	
30	U-forend 5 mm		1100000002642	4021226943052	non	1	
35	U-forend 5 mm		1100000002643	4021226943076	non	1	
40	U-forend 5 mm		1100000002644	4021226943090	non	1	
45	U-forend 5 mm		1100000002645	4021226943113	non	1	
50	U-forend 5 mm		1100000002646	4021226943137	non	1	
55	U-forend 5 mm		1100000002647	4021226943151	non	1	
60	U-forend 5 mm		1100000002648	4021226943175	non	1	
25	Flat forend 3 mm		1100000002649	4021226943199	non	1	
30	Flat forend 3 mm		1100000002650	4021226943212	non	1	
35	Flat forend 3 mm		1100000002651	4021226943236	non	1	
40	Flat forend 3 mm		1100000002652	4021226943250	non	1	
45	Flat forend 3 mm		1100000002653	4021226943274	non	1	
50	Flat forend 3 mm		1100000002654	4021226943298	non	1	
55	Flat forend 3 mm		1100000002655	4021226943311	non	1	
60	Flat forend 3 mm		1100000002656	4021226943335	non	1	

 **Black-painted steel**

Backset mm	Forend mm	Ld	Order No.	EAN	Handed	Packaging Unit	Gross Price per piece EURO
25	U-forend 6 mm		1100000002657	4021226943359	non	1	
30	U-forend 6 mm		1100000002658	4021226943373	non	1	
35	U-forend 6 mm		1100000002659	4021226943397	non	1	
40	U-forend 6 mm		1100000002660	4021226943410	non	1	
45	U-forend 6 mm		1100000002661	4021226943434	non	1	
50	U-forend 6 mm		1100000002662	4021226943458	non	1	
55	U-forend 6 mm		1100000002663	4021226943472	non	1	
60	U-forend 6 mm		1100000002664	4021226943496	non	1	
25	U-forend 5 mm		1100000002665	4021226943519	non	1	
30	U-forend 5 mm		1100000002666	4021226943533	non	1	
35	U-forend 5 mm		1100000002667	4021226943557	non	1	
40	U-forend 5 mm		1100000002668	4021226943571	non	1	
45	U-forend 5 mm		1100000002669	4021226943595	non	1	
50	U-forend 5 mm		1100000002670	4021226943618	non	1	
55	U-forend 5 mm		1100000002671	4021226943632	non	1	
60	U-forend 5 mm		1100000002672	4021226943656	non	1	
25	Flat forend 3 mm		1100000002673	4021226943670	non	1	
30	Flat forend 3 mm		1100000002674	4021226943694	non	1	
34	Flat forend 3 mm		1100000002675	4021226943717	non	1	
40	Flat forend 3 mm		1100000002676	4021226943731	non	1	
45	Flat forend 3 mm		1100000002677	4021226943755	non	1	
50	Flat forend 3 mm		1100000002678	4021226943779	non	1	
55	Flat forend 3 mm		1100000002679	4021226943793	non	1	
60	Flat forend 3 mm		1100000002680	4021226943816	non	1	

# MULTIPOINT DEADBOLT LOCK 92 MM DISTANCE

## 810 series

- Lateral locking: sliding deadbolts
- Central lock; center distance 92 mm; for operation with europrofile cylinder
- Throw: 20 mm; Follower: 8 mm
- The latch can be replaced by roller or cap
- The lock is equipped with a wheel-cam stopping device if the cylinder is not fitted inside the lock case
- Accessories to be ordered separately:
  - Roller for central lock 1100000002760
  - Cap for deadbolt only versions 1100000002761

- R Reversible latch bolt
- Stainless steel

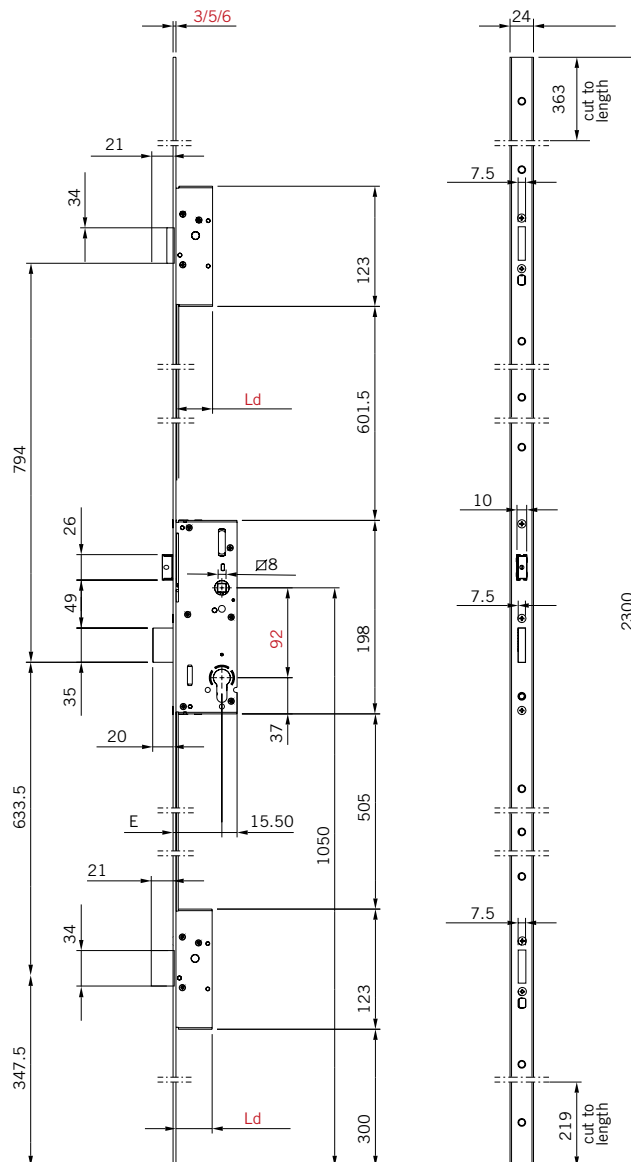

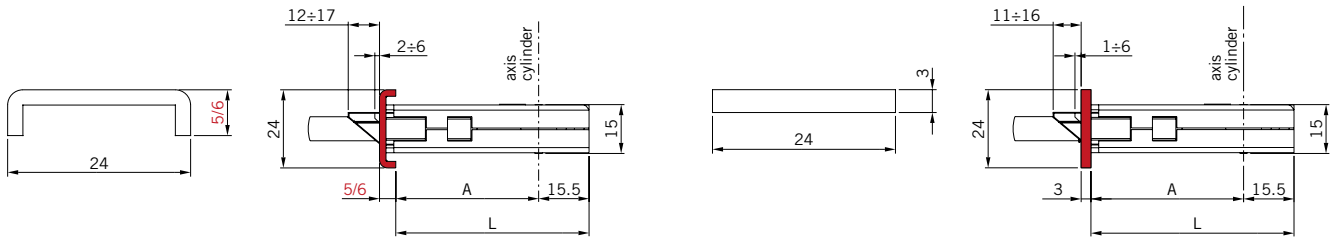

Stainless steel

Backset mm	Forend mm	Ld	Order No.	EAN	Handed	Packaging Unit	Gross Price per piece EURO
25	U-forend 6 mm		1100000002705	4021226944318	non	1	
30	U-forend 6 mm		1100000002706	4021226944332	non	1	
35	U-forend 6 mm		1100000002707	4021226944356	non	1	
40	U-forend 6 mm		1100000002708	4021226944370	non	1	
45	U-forend 6 mm		1100000002709	4021226944394	non	1	
50	U-forend 6 mm		1100000002710	4021226944417	non	1	
55	U-forend 6 mm		1100000002711	4021226944431	non	1	
60	U-forend 6 mm		1100000002712	4021226944455	non	1	
25	U-forend 5 mm		1100000002713	4021226944479	non	1	
30	U-forend 5 mm		1100000002714	4021226944493	non	1	
35	U-forend 5 mm		1100000002715	4021226944516	non	1	
40	U-forend 5 mm		1100000002716	4021226944530	non	1	
45	U-forend 5 mm		1100000002717	4021226944554	non	1	
50	U-forend 5 mm		1100000002718	4021226944578	non	1	
55	U-forend 5 mm		1100000002719	4021226944592	non	1	
60	U-forend 5 mm		1100000002720	4021226944615	non	1	
25	Flat forend 3 mm		1100000002721	4021226944639	non	1	
30	Flat forend 3 mm		1100000002722	4021226944653	non	1	
35	Flat forend 3 mm		1100000002723	4021226944677	non	1	
40	Flat forend 3 mm		1100000002724	4021226944691	non	1	
45	Flat forend 3 mm		1100000002725	4021226944714	non	1	
50	Flat forend 3 mm		1100000002726	4021226944738	non	1	
55	Flat forend 3 mm		1100000002727	4021226944752	non	1	
60	Flat forend 3 mm		1100000002728	4021226944776	non	1	

# ACCESSORIES

---

Reinforced anti-saw deadbolts. 85 mm center center distance

- Can replace standard deadbolt

---

■ **Stainless steel**

Feature	Order No.	EAN	Packaging Unit	Minimal Order	Gross Price per piece EURO
U-forend 2300 x 24 x 6 mm	1100000003186	4021226953792	1		
U-forend 2300 x 24 x 6 mm	1100000003187	4021226953815	1		
U-forend 2300 x 24 x 6 mm	1100000003188	4021226953839	1		
U-forend 2300 x 24 x 6 mm	1100000003189	4021226953853	1		
U-forend 2300 x 24 x 6 mm	1100000003190	4021226953877	1		
U-forend 2300 x 24 x 6 mm	1100000003191	4021226953891	1		
U-forend 2300 x 24 x 5 mm	1100000003192	4021226953914	1		
U-forend 2300 x 24 x 5 mm	1100000003193	4021226953938	1		
U-forend 2300 x 24 x 5 mm	1100000003194	4021226953952	1		
U-forend 2300 x 24 x 5 mm	1100000003195	4021226953976	1		
U-forend 2300 x 24 x 5 mm	1100000003196	4021226953990	1		
U-forend 2300 x 24 x 5 mm	1100000003197	4021226954010	1		
Flat forend 2300 x 24 x 3 mm	1100000003198	4021226954034	1		
Flat forend 2300 x 24 x 3 mm	1100000003199	4021226954058	1		
Flat forend 2300 x 24 x 3 mm	1100000003200	4021226954072	1		
Flat forend 2300 x 24 x 3 mm	1100000003201	4021226954096	1		
Flat forend 2300 x 24 x 3 mm	1100000003202	4021226954119	1		
Flat forend 2300 x 24 x 3 mm	1100000003203	4021226954133	1		

Reinforced anti-saw deadbolts. 92 mm center center distance

- Can replace standard deadbolt

Stainless steel					
Feature	Order No.	EAN	Packaging Unit	Minimal Order	Gross Price per piece EURO
U-forend 2300 x 24 x 6 mm	1100000003204	4021226954157	1		
U-forend 2300 x 24 x 6 mm	1100000003205	4021226954171	1		
U-forend 2300 x 24 x 6 mm	1100000003206	4021226954195	1		
U-forend 2300 x 24 x 6 mm	1100000003207	4021226954218	1		
U-forend 2300 x 24 x 6 mm	1100000003208	4021226954232	1		
U-forend 2300 x 24 x 6 mm	1100000003209	4021226954256	1		
U-forend 2300 x 24 x 5 mm	1100000003210	4021226954270	1		
U-forend 2300 x 24 x 5 mm	1100000003211	4021226954294	1		
U-forend 2300 x 24 x 5 mm	1100000003212	4021226954317	1		
U-forend 2300 x 24 x 5 mm	1100000003213	4021226954331	1		
U-forend 2300 x 24 x 5 mm	1100000003214	4021226954355	1		
U-forend 2300 x 24 x 5 mm	1100000003215	4021226954379	1		
Flat forend 2300 x 24 x 3 mm	1100000003216	4021226954393	1		
Flat forend 2300 x 24 x 3 mm	1100000003217	4021226954416	1		
Flat forend 2300 x 24 x 3 mm	1100000003218	4021226954430	1		
Flat forend 2300 x 24 x 3 mm	1100000003219	4021226954454	1		
Flat forend 2300 x 24 x 3 mm	1100000003220	4021226954478	1		
Flat forend 2300 x 24 x 3 mm	1100000003221	4021226954492	1		

Adjustable closed striking plate for central lock for 601 and 810 series

- Forend vertical adjustment from 7 to 12 mm and horizontal adjustment  $\pm$  mm 2

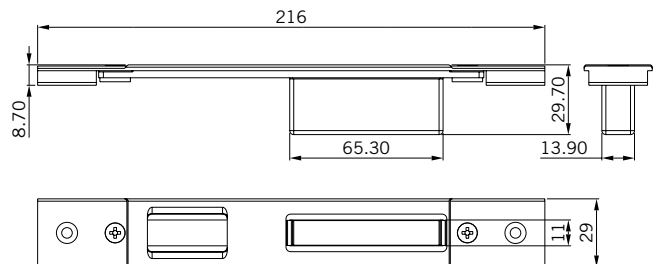

Black-painted steel					
Feature	Order No.	EAN	Packaging Unit	Minimal Order	Gross Price per piece EURO
Flat forend 22 x 216 mm	1100000002763	4021226945476	10		

Adjustable closed striking plate for central lock for 601 and 810 series

- Forend vertical adjustment through threaded plates and horizontal adjustment  $\pm$  mm 9

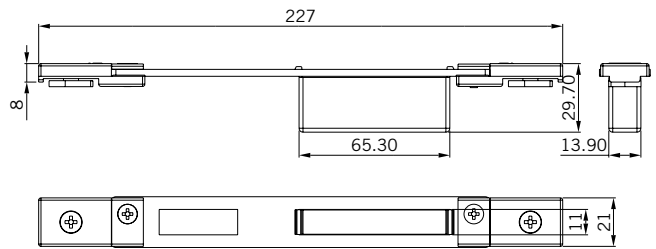

**Black-painted steel**

Feature	Order No.	EAN	Packaging Unit	Minimal Order	Gross Price per piece EURO
Flat forend 22 x 227 mm	1100000002764	4021226945490	10		

Adjustable closed striking plate for central lock for 601 and 810 series

- Forend horizontal adjustment  $\pm$  9 mm

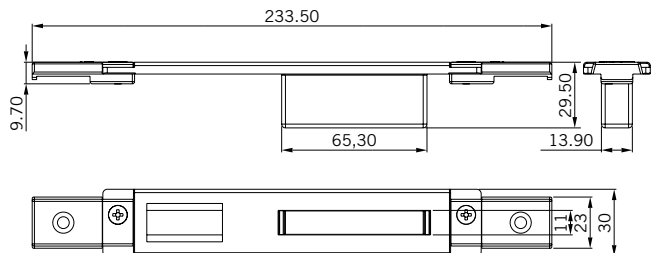

**Black-painted zamak**

Feature	Order No.	EAN	Packaging Unit	Minimal Order	Gross Price per piece EURO
Flat forend 30 x 5,1 x 233.5 mm	1100000002765	4021226945513	10		

Adjustable closed striking plate for central lock for 601 and 810 series

- Forend horizontal adjustment  $\pm$  9 mm

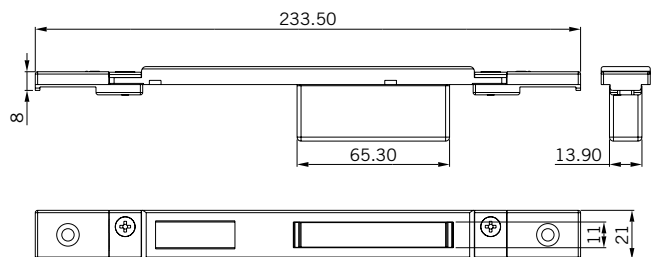

**Black-painted zamak**

Feature	Order No.	EAN	Packaging Unit	Minimal Order	Gross Price per piece EURO
Flat forend 21 x 8 x 233.5 mm	1100000002766	4021226945537	10		



### Adjustable closed striking plate for central lock for 601 and 810 series

- Forend horizontal adjustment  $\pm 13$  mm

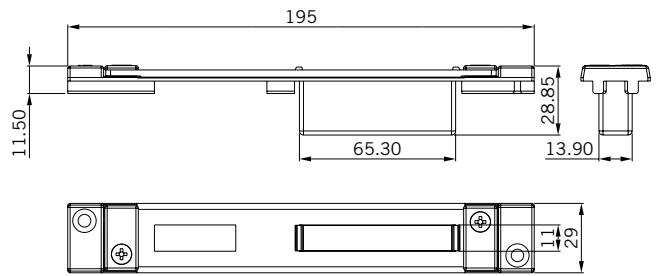

**Black-painted steel**

Feature	Order No.	EAN	Packaging Unit	Minimal Order	Gross Price per piece EURO
Flat forend 29 x 195 mm	1100000002767	4021226945551	10		

### Adjustable closed striking plate for lateral lock for 810 series

- Forend vertical adjustment from 7 to 12 mm and horizontal adjustment  $\pm 2$  mm

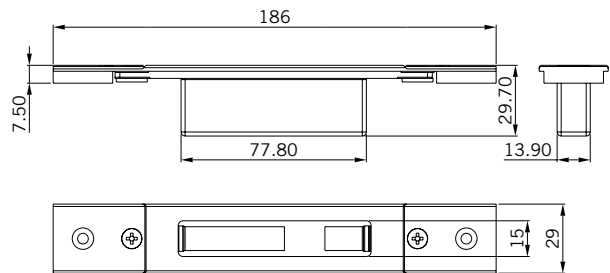

**Black-painted steel**

Feature	Order No.	EAN	Packaging Unit	Minimal Order	Gross Price per piece EURO
Flat forend 29 x 186 mm	1100000002768	4021226945575	10		

### Adjustable closed striking plate for lateral lock for 810 series

- Forend vertical adjustment through threaded plates and horizontal adjustment  $\pm 9$  mm

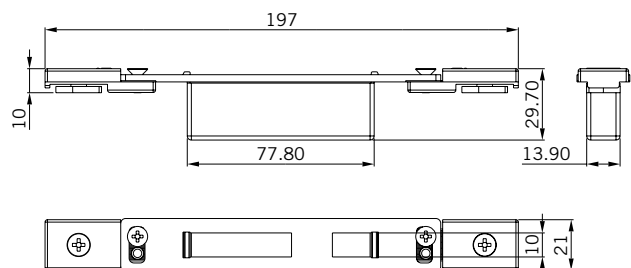

**Black-painted steel**

Feature	Order No.	EAN	Packaging Unit	Minimal Order	Gross Price per piece EURO
Flat forend 22 x 197 mm	1100000002769	4021226945599	10		

### Adjustable closed striking plate for lateral lock for 810 series

- Forend horizontal adjustment  $\pm 9$  mm

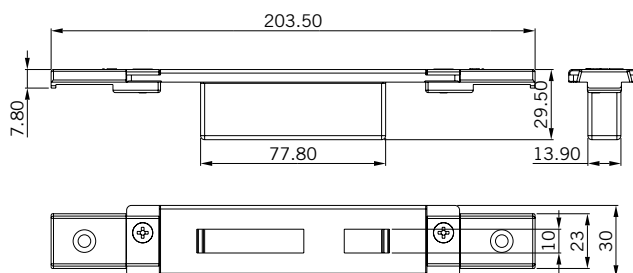

**Black-painted zamak**

Feature	Order No.	EAN	Packaging Unit	Minimal Order	Gross Price per piece EURO
Flat forend 30 x 5.5 x 203.5 mm	1100000002770	4021226945612	10		

### Adjustable closed striking plate for lateral lock for 810 series

- Forend horizontal adjustment  $\pm 9$  mm

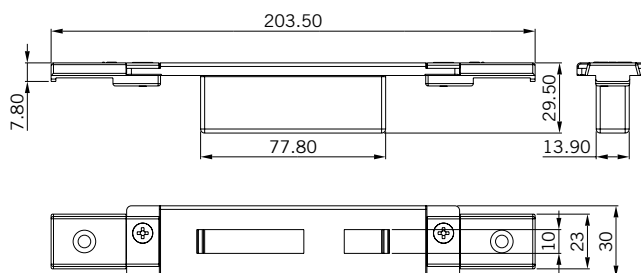

**Black-painted zamak**

Feature	Order No.	EAN	Packaging Unit	Minimal Order	Gross Price per piece EURO
Flat forend 21 x 8 x 203.5 mm	1100000002771	4021226945636	10		

### Adjustable closed striking plate for lateral lock for 810 series

- Forend horizontal adjustment  $\pm 13$  mm

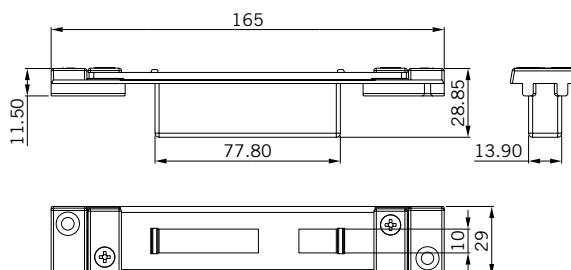

**Black-painted steel**

Feature	Order No.	EAN	Packaging Unit	Minimal Order	Gross Price per piece EURO
Flat forend 29 x 165 mm	1100000002772	4021226945650	10		

Striking plates for central lock 601 and 810 series

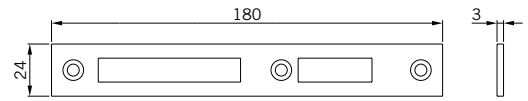

■ Stainless steel

Feature	Order No.	EAN	Packaging Unit	Minimal Order	Gross Price per piece EURO
Flat forend 24 x 3 x 180 mm	1100000002773	4021226945674	10		
Flat forend 24 x 3 x 180 mm	1100000002774	4021226945698	10		

Striking plates for central lock 601 and 810 series

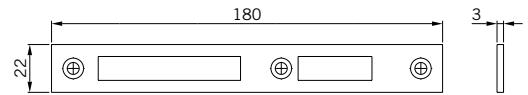

■ Stainless steel

Feature	Order No.	EAN	Packaging Unit	Minimal Order	Gross Price per piece EURO
Flat forend 22 x 3 x 180 mm	1100000002775	4021226945711	10		

Striking plates for central lock 601 and 810 series

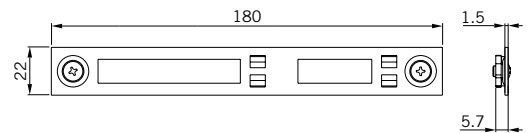

■ Stainless steel

Feature	Order No.	EAN	Packaging Unit	Minimal Order	Gross Price per piece EURO
Flat forend 22 x 1.5 x 180 mm	1100000002776	4021226945735	10		

Striking plates for central lock 601 and 810 series

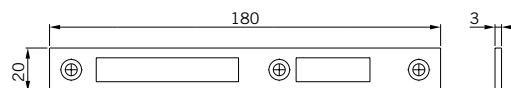

■ Stainless steel

Feature	Order No.	EAN	Packaging Unit	Minimal Order	Gross Price per piece EURO
Flat forend 20 x 3 x 180 mm	1100000002777	4021226945759	10		

Striking plates for central lock 601 and 810 series

- Forend for round ends

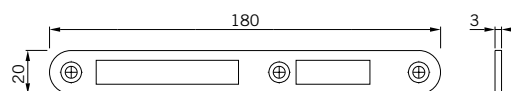

■ Stainless steel

Feature	Order No.	EAN	Packaging Unit	Minimal Order	Gross Price per piece EURO
Flat forend 20 x 3 x 180 mm	1100000002778	4021226945773	10		

Striking plates for lateral lock 810 series

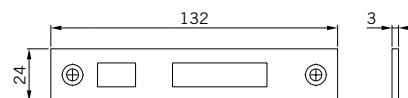

■ Stainless steel

Feature	Order No.	EAN	Packaging Unit	Minimal Order	Gross Price per piece EURO
Flat forend 24 x 3 x 132 mm	1100000002779	4021226945797	10		
Flat forend 24 x 3 x 132 mm	1100000002780	4021226945810	10		

Striking plates for lateral lock 810 series

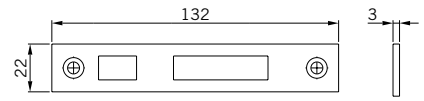

■ Stainless steel

Feature	Order No.	EAN	Packaging Unit	Minimal Order	Gross Price per piece EURO
Flat forend 22 x 3 x 132 mm	1100000002781	4021226945834	10		

Striking plates for lateral lock 810 series

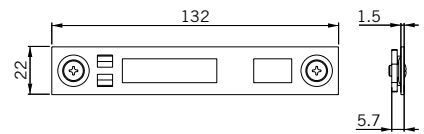

■ Stainless steel

Feature	Order No.	EAN	Packaging Unit	Minimal Order	Gross Price per piece EURO
Flat forend 22 x 1.5 x 132 mm	1100000002782	4021226945858	10		

Striking plates for lateral lock 810 series

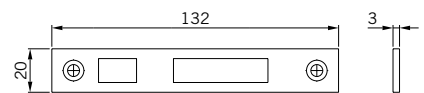

■ Stainless steel

Feature	Order No.	EAN	Packaging Unit	Minimal Order	Gross Price per piece EURO
Flat forend 22 x 3 x 132 mm	1100000002783	4021226945872	10		

Striking plates for lateral lock 810 series

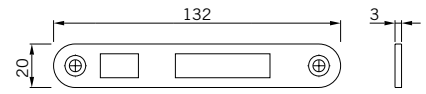

■ Stainless steel

Feature	Order No.	EAN	Packaging Unit	Minimal Order	Gross Price per piece EURO
Flat forend 20 x 3 x 132 mm	1100000002784	4021226945896	10		

## Roller kit for 810 series

- Can replace the latch
- With nylon inserts
- For locks with backsets of 25, 30, 35, 40, 45, 50, 55 or 60 mm



Order No.	EAN	Packaging Unit	Minimal Order	Gross Price per piece EURO
1100000002760	4021226945414	10		

## Cap kit for 810 series

- Can replace the latch for only deadbolt versions
- With nylon inserts
- For locks with backsets of 25, 30, 35, 40, 45, 50, 55 or 60 mm



Order No.	EAN	Packaging Unit	Minimal Order	Gross Price per piece EURO
1100000002761	4021226945438	10		

## Latch bolt kit for 810 series

- For locks with backsets of 25, 30, 35, 40, 45, 50, 55 or 60 mm



Order No.	EAN	Packaging Unit	Minimal Order	Gross Price per piece EURO
1100000002762	4021226945452	10		

# MODULAR MULTIPOINT ROTATING DEADBOLT LOCK

## 840 series

- Modular mortise lock for multipoint locking incl. rotating deadbolt and forend with holes for additional bolts
- Central lock; center distance 92 mm; for operation with europrofile cylinder
- Throw: 27 mm with anti-drill and anti-cut cover plates in carbo-nitrided steel
- Reversible & adjustable latch - can be replaced by roller or cap for deadlocking only
- Built-in connecting rods between lock and bolts
- Accessories to be ordered separately:
- Rotating deadbolt bolt 1100000002859, Rotating hook bolt 1100000002860, Bottom-locking bolt 1100000002857, Top-locking bolt 1100000002858, Modular roller for latch hole - e.g. 1100000002961, Cylinder escutcheon 1100000002979, Anti-drill plate

- R** Reversible latch bolt
- P** 3-point locking
- Stainless steel

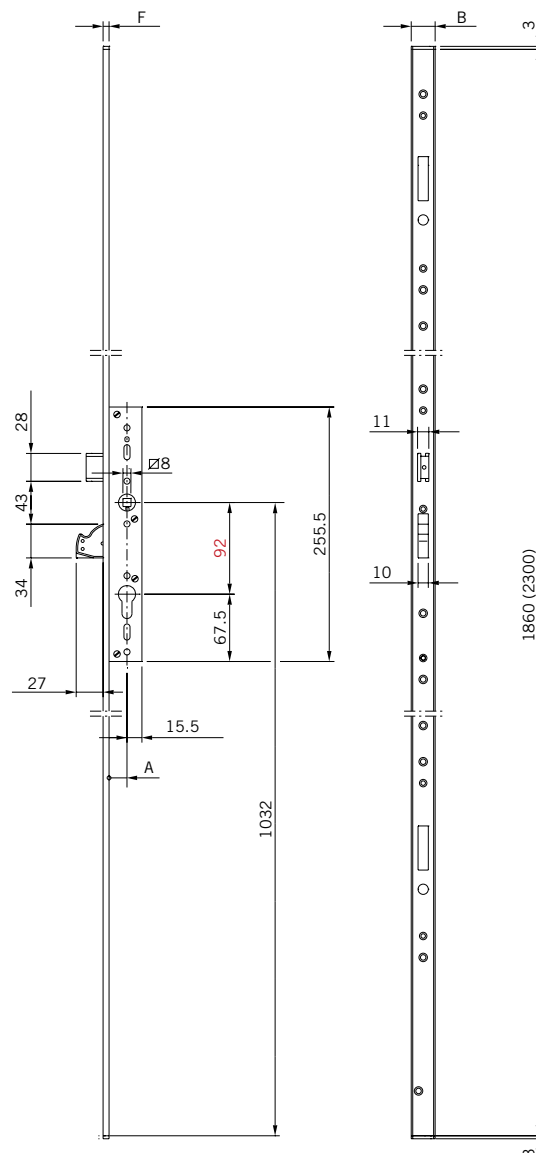



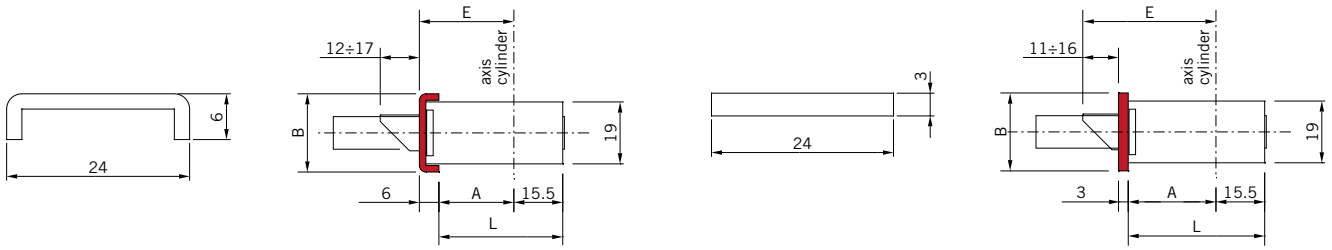

Stainless steel

Backset mm	Forend mm	Ld	Order No.	EAN	Handed	Packaging Unit	Gross Price per piece EURO
25	U-forend 6 mm		1100000002837	4021226946855	non	1	
30	U-forend 6 mm		1100000002838	4021226946879	non	1	
35	U-forend 6 mm		1100000002839	4021226946893	non	1	
40	U-forend 6 mm		1100000002840	4021226946916	non	1	
25	U-forend 6 mm		1100000002841	4021226946930	non	1	
30	U-forend 6 mm		1100000002842	4021226946954	non	1	
35	U-forend 6 mm		1100000002843	4021226946978	non	1	
40	U-forend 6 mm		1100000002844	4021226946992	non	1	
25	U-forend 5 mm		1100000002845	4021226947012	non	1	
30	U-forend 5 mm		1100000002846	4021226947036	non	1	
35	U-forend 5 mm		1100000002847	4021226947050	non	1	
40	U-forend 5 mm		1100000002848	4021226947074	non	1	
25	Flat forend 3 mm		1100000002849	4021226947098	non	1	
30	Flat forend 3 mm		1100000002850	4021226947111	non	1	
35	Flat forend 3 mm		1100000002851	4021226947135	non	1	
40	Flat forend 3 mm		1100000002852	4021226947159	non	1	
25	U-forend 7 mm		1100000002853	4021226947173	non	1	
30	U-forend 7 mm		1100000002854	4021226947197	non	1	
35	U-forend 7 mm		1100000002855	4021226947210	non	1	
40	U-forend 7 mm		1100000002856	4021226947234	non	1	

# ACCESSORIES

---

## Lateral locks for 840 series

- Lower locking, to be applied to the modular forend
- M8 threaded square for tip bolt
- Multi-faceted, anti-screw tip bolt Ø 14x55 mm with threaded hole M8; tip length 20 mm
- Anti-dust brass rod cap Ø 18 mm; screws and pins included
- Accessories to be ordered separately: Floor socket 1100000002977

Order No.	EAN	Packaging Unit	Minimal Order	Gross Price per piece EURO
1100000002857	4021226947258	1		

## Lateral locks for 840 series

- Upper locking, to be applied to the modular forend
- M8 threaded square for tip bolt
- Multi-faceted, anti-screw tip bolt Ø 14x55 mm with threaded hole M8; tip length 20 mm
- Galvanized plate and nylon tip-guiding spacer; screws and pins included
- Accessories to be ordered separately: Upper striker 1100000002976

Order No.	EAN	Packaging Unit	Minimal Order	Gross Price per piece EURO
1100000002858	4021226947272	1		

## Lateral locks for 840 series

- Lateral locking, to be applied to the modular forend
- Rotating deadbolt with anti-drill and anti-cut cover plates in carbo-nitrided steel
- Throw: 27 mm
- Accessories to be ordered separately: striking plates

Order No.	EAN	Packaging Unit	Minimal Order	Gross Price per piece EURO
1100000002859	4021226947296	1		

## Lateral locks for 840 series

- Lateral locking, to be applied to the modular forend
- Rotating hook clearance mm 15.5 mm with anti-drill and anti-cut cover plates in carbo-nitrided steel and sliding latch
- Throw: 26.5 mm
- Accessories to be ordered separately: striking plates

Order No.	EAN	Packaging Unit	Minimal Order	Gross Price per piece EURO
1100000002860	4021226947319	1		

# MULTIPOINT LOCK WITH ROTATING DEADBOLTS

## 840 series

- 3 rotating deadbolts with anti-drill/anti-cut cover plates in carbo-nitrided steel
- Central lock; center distance 92 mm; for operation with europrofile cylinder
- Throw: 27 mm
- Reversible and adjustable latch which can be replaced by roller or cap for deadlocking only
- Latch bolt/roller operated by key or handle
- Follower: 8 mm
- 2 nylon end blocks for U-version

- R Reversible latch bolt
- P 3-point locking
- Stainless steel

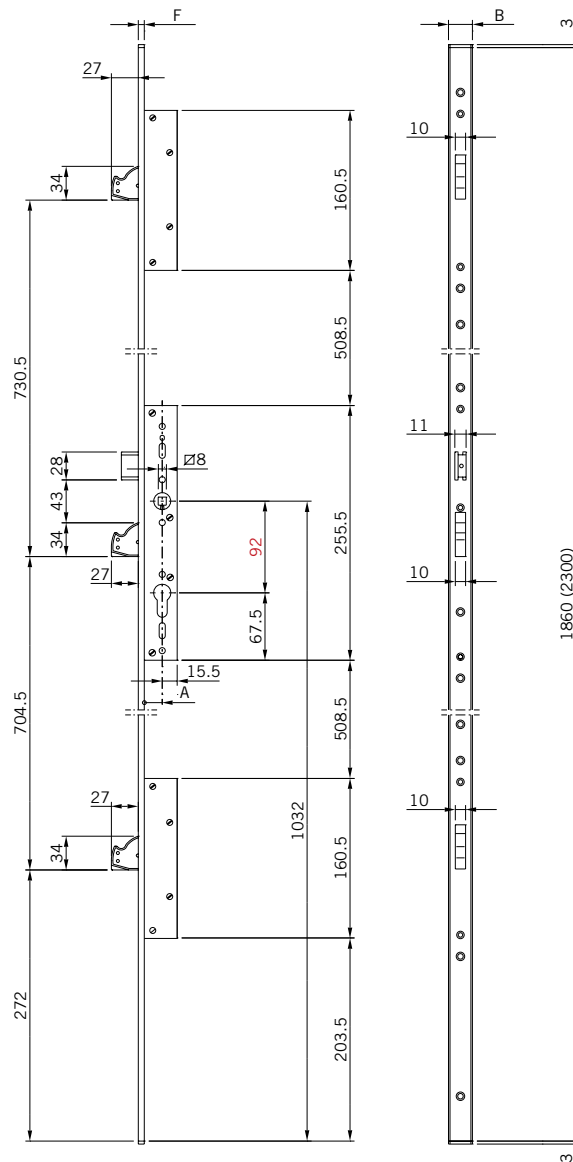

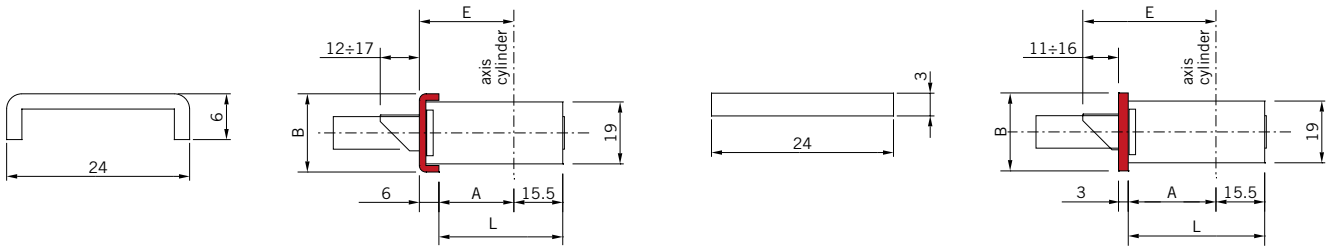

**Stainless steel**

Backset mm	Forend mm	Ld	Order No.	EAN	Handed	Packaging Unit	Gross Price per piece EURO
25	U-forend 6 mm		1100000002861	4021226947333	non	1	
30	U-forend 6 mm		1100000002862	4021226947357	non	1	
35	U-forend 6 mm		1100000002863	4021226947371	non	1	
40	U-forend 6 mm		1100000002864	4021226947395	non	1	
45	U-forend 6 mm		1100000002865	4021226947418	non	1	
50	U-forend 6 mm		1100000002866	4021226947432	non	1	
55	U-forend 6 mm		1100000002867	4021226947456	non	1	
60	U-forend 6 mm		1100000002868	4021226947470	non	1	
65	U-forend 6 mm		1100000002869	4021226947494	non	1	
25	U-forend 6 mm		1100000002870	4021226947517	non	1	
30	U-forend 6 mm		1100000002871	4021226947531	non	1	
35	U-forend 6 mm		1100000002872	4021226947555	non	1	
40	U-forend 6 mm		1100000002873	4021226947579	non	1	
45	U-forend 6 mm		1100000002874	4021226947593	non	1	
50	U-forend 6 mm		1100000002875	4021226947616	non	1	
55	U-forend 6 mm		1100000002876	4021226947630	non	1	
60	U-forend 6 mm		1100000002877	4021226947654	non	1	
65	U-forend 6 mm		1100000002878	4021226947678	non	1	
25	U-forend 5 mm		1100000002879	4021226947692	non	1	
30	U-forend 5 mm		1100000002880	4021226947715	non	1	
35	U-forend 5 mm		1100000002881	4021226947739	non	1	
40	U-forend 5 mm		1100000002882	4021226947753	non	1	
45	U-forend 5 mm		1100000002883	4021226947777	non	1	

Stainless steel							
Backset mm	Forend mm	Ld	Order No.	EAN	Handed	Packaging Unit	Gross Price per piece EURO
50	U-forend 5 mm		1100000002884	4021226947791	non	1	
55	U-forend 5 mm		1100000002885	4021226947814	non	1	
60	U-forend 5 mm		1100000002886	4021226947838	non	1	
65	U-forend 5 mm		1100000002887	4021226947852	non	1	
25	Flat forend 3 mm		1100000002888	4021226947876	non	1	
30	Flat forend 3 mm		1100000002889	4021226947890	non	1	
35	Flat forend 3 mm		1100000002890	4021226947913	non	1	
40	Flat forend 3 mm		1100000002891	4021226947937	non	1	
45	Flat forend 3 mm		1100000002892	4021226947951	non	1	
50	Flat forend 3 mm		1100000002893	4021226947975	non	1	
55	Flat forend 3 mm		1100000002894	4021226947999	non	1	
60	Flat forend 3 mm		1100000002895	4021226948019	non	1	
65	Flat forend 3 mm		1100000002896	4021226948033	non	1	
25	U-forend 7 mm		1100000002897	4021226948057	non	1	
30	U-forend 7 mm		1100000002898	4021226948071	non	1	
35	U-forend 7 mm		1100000002899	4021226948095	non	1	
40	U-forend 7 mm		1100000002900	4021226948118	non	1	

# MULTIPOINT LOCK WITH ROTATING HOOK BOLTS

## 840 series

- Rotating deadbolt, rotating hooks and sliding deadbolts with anti-drill/anti-cut cover plates in carbo-nitrided steel; Hook bolt clearance 15.5 mm
- Central lock; center distance 92 mm; for operation with europrofile cylinder
- Throw: 27 mm; Follower: 8 mm
- Reversible & adjustable latch - can be replaced by roller or cap for deadlocking only
- Latch bolt/roller operated by key or handle
- Accessories to be ordered separately:
- Modular roller for latch hole - e.g. 1100000002961, Modular cap for latch hole 1100000002961 - 1100000003279, Cylinder escutcheon 1100000002979, Anti-drill plate - e.g. 1100000003245

- R Reversible latch bolt
- H Rotating hook bolt
- P 3-point locking
- Stainless steel

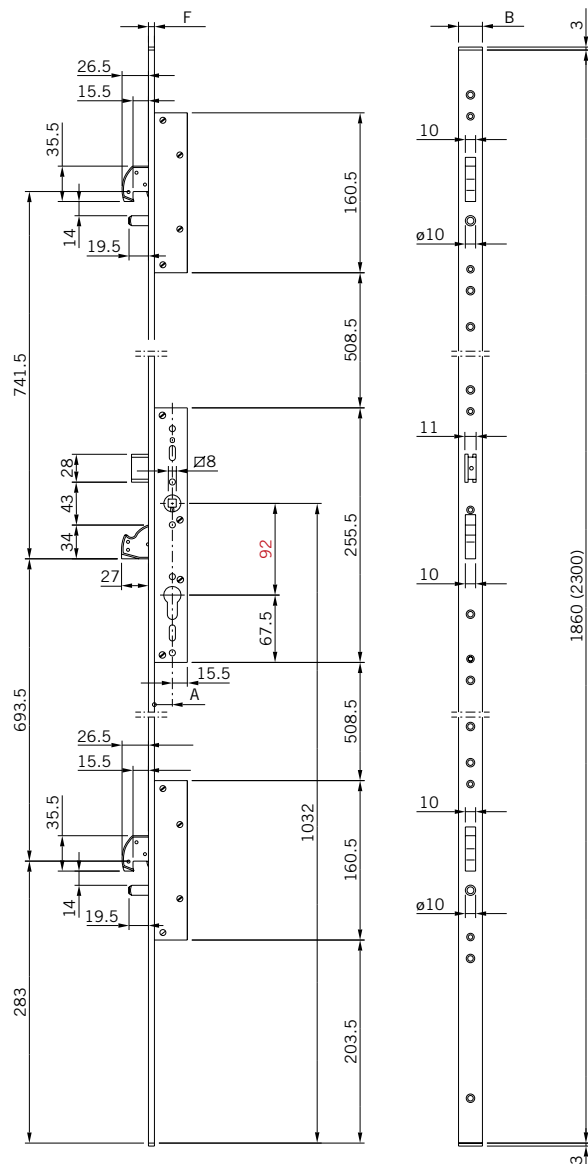

**MULTIPOINT LOCK 840 SERIES MULTIPOINT LOCK WITH ROTATING HOOK BOLTS**

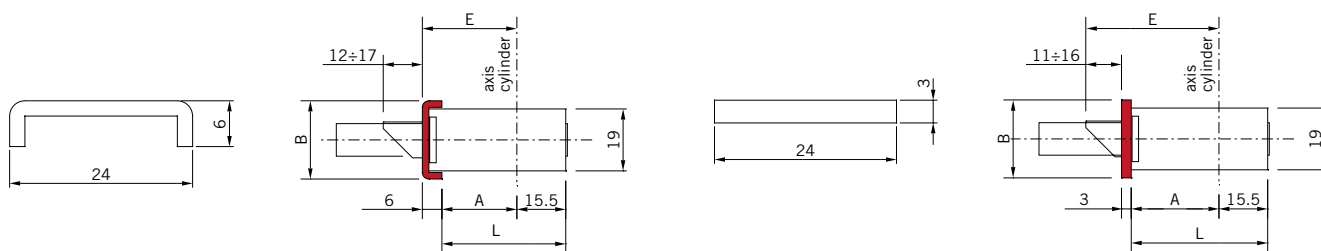

**Stainless steel**

Backset mm	Forend mm	Ld	Order No.	EAN	Handed	Packaging Unit	Gross Price per piece EURO
25	U-forend 6 mm		1100000002901	4021226948132	non	1	
30	U-forend 6 mm		1100000002902	4021226948156	non	1	
35	U-forend 6 mm		1100000002903	4021226948170	non	1	
40	U-forend 6 mm		1100000002904	4021226948194	non	1	
45	U-forend 6 mm		1100000002905	4021226948217	non	1	
50	U-forend 6 mm		1100000002906	4021226948231	non	1	
55	U-forend 6 mm		1100000002907	4021226948255	non	1	
60	U-forend 6 mm		1100000002908	4021226948279	non	1	
65	U-forend 6 mm		1100000002909	4021226948293	non	1	
25	U-forend 6 mm		1100000002910	4021226948316	non	1	
30	U-forend 6 mm		1100000002911	4021226948330	non	1	
35	U-forend 6 mm		1100000002912	4021226948354	non	1	
40	U-forend 6 mm		1100000002913	4021226948378	non	1	
45	U-forend 6 mm		1100000002914	4021226948392	non	1	
50	U-forend 6 mm		1100000002915	4021226948415	non	1	
55	U-forend 6 mm		1100000002916	4021226948439	non	1	
60	U-forend 6 mm		1100000002917	4021226948453	non	1	
65	U-forend 6 mm		1100000002918	4021226948477	non	1	
25	U-forend 5 mm		1100000002928	4021226948675	non	1	
30	U-forend 5 mm		1100000002929	4021226948699	non	1	
35	U-forend 5 mm		1100000002930	4021226948712	non	1	
40	U-forend 5 mm		1100000002931	4021226948736	non	1	
45	U-forend 5 mm		1100000002932	4021226948750	non	1	



Stainless steel

Backset mm	Forend mm	Ld	Order No.	EAN	Handed	Packaging Unit	Gross Price per piece EURO
50	U-forend 5 mm		1100000002933	4021226948774	non	1	
55	U-forend 5 mm		1100000002934	4021226948798	non	1	
60	U-forend 5 mm		1100000002935	4021226948811	non	1	
65	U-forend 5 mm		1100000002936	4021226948835	non	1	
25	Flat forend 3 mm		1100000002919	4021226948491	non	1	
30	Flat forend 3 mm		1100000002920	4021226948514	non	1	
35	Flat forend 3 mm		1100000002921	4021226948538	non	1	
40	Flat forend 3 mm		1100000002922	4021226948552	non	1	
45	Flat forend 3 mm		1100000002923	4021226948576	non	1	
50	Flat forend 3 mm		1100000002924	4021226948590	non	1	
55	Flat forend 3 mm		1100000002925	4021226948613	non	1	
60	Flat forend 3 mm		1100000002926	4021226948637	non	1	
65	Flat forend 3 mm		1100000002927	4021226948651	non	1	
25	U-forend 7 mm		1100000002937	4021226948859	non	1	
30	U-forend 7 mm		1100000002938	4021226948873	non	1	
35	U-forend 7 mm		1100000002939	4021226948897	non	1	
40	U-forend 7 mm		1100000002940	4021226948910	non	1	

# ACCESSORIES

## Modular roller for 840 and 602 series

- With nylon insert for fixed and adjustable striking plate
- Can replace the latch



Feature	Order No.	EAN	Packaging Unit	Minimal Order	Gross Price per piece EURO
For lock backset 25 mm	1100000002961	4021226949337	10		
For lock backset 30mm	1100000002962	4021226949351	10		
For lock backset 35 mm	1100000002963	4021226949375	10		
For lock backset 40 mm	1100000002964	4021226949399	10		
For lock backset 45 mm	1100000002965	4021226949412	10		
For lock backset 50 mm	1100000002966	4021226949436	10		
For lock backset 55 mm	1100000002967	4021226949450	10		
For lock backset 60 mm	1100000002968	4021226949474	10		
For lock backset 65 mm	1100000002969	4021226949498	10		

## Modular anti-drill plate for 840 and 602 series

- To be fixed to the lock for pin protection



Feature	Order No.	EAN	Packaging Unit	Minimal Order	Gross Price per piece EURO
For lock backset 25 mm	1100000002972	4021226949511	10		
For lock backset 30 mm	1100000002973	4021226949535	10		
For lock backset 35 mm	1100000002974	4021226949559	10		
For lock backset 40 mm	1100000002975	4021226949573	10		
For lock backset 45 mm	1100000003245	4021226954973	10		
For lock backset 50 mm	1100000003246	4021226954997	10		
For lock backset 55 mm	1100000003247	4021226955017	10		
For lock backset 60 mm	1100000003248	4021226955031	10		
For lock backset 65 mm	1100000003249	4021226955055	10		

## Modular escutcheon for 840 and 602 series

- For operation with europrofile cylinder; internal fixing
- Internal and external escutcheons in aluminum
- External plate and anti-drill disk in carbo-nitrided steel
- Plate spacer
- Anti-drill balls for screw protection

**Black-painted aluminum**

Feature	Order No.	EAN	Packaging Unit	Minimal Order	Gross Price per piece EURO
Black-painted aluminum	1100000002979	4021226949658	1		
Mill aluminum	1100000002980	4021226949672	1		

# ACCESSORIES

## Modular cap for 840 and 602 series

- For backset from 25 mm to 65 mm
- To be fitted instead of the latch for deadbolt only versions



Nylon

Order No.	EAN	Packaging Unit	Minimal Order	Gross Price per piece EURO
1100000003279	4021226955659	10		

## Roller nylon insert for 840 and 610 series

- For adjustable striking plates

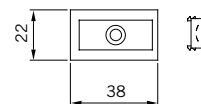

Nylon

Order No.	EAN	Packaging Unit	Minimal Order	Gross Price per piece EURO
1100000003185	4021226953778	10		

## Upper striker for 840 series

- Vertical locking
- 2 tip-guiding plates Ø 14 mm
- Rod-guiding nylon spacer



Order No.	EAN	Packaging Unit	Minimal Order	Gross Price per piece EURO
1100000002976	4021226949597	10		

## Brass floor socket with anti-dust spring cap for rods for 840 series

- Inside hole  $\varnothing$  18 mm



Order No.	EAN	Packaging Unit	Minimal Order	Gross Price per piece EURO
1100000002977	4021226949610	10		

## Multi-faceted tip for threaded rods for 840 series

- Tip  $\varnothing$  14 mm
- Elastic, pull pin



Order No.	EAN	Packaging Unit	Minimal Order	Gross Price per piece EURO
1100000002978	4021226949634	10		

## Pair of nylon forend supports

- For operation with europrofile cylinder and two-piece rail frames
- 22 x 8 mm



Order No.	EAN	Packaging Unit	Minimal Order	Gross Price per piece EURO
1100000003015	4021226950371	10		

Adjustable mechanical striker for central striking plate 840 series

- For series 1100000002981-1100000002982-  
1100000002983-1100000002984-1100000002993-  
1100000002994-1100000002995-1100000002996



■ Stainless steel				
Order No.	EAN	Packaging Unit	Minimal Order	Gross Price per piece EURO
1100000003022	4021226950517	1		

# STRIKING PLATES

## Adjustable closed striking plate for central lock for 840 series

- To be used with mechanical striker 110000003022

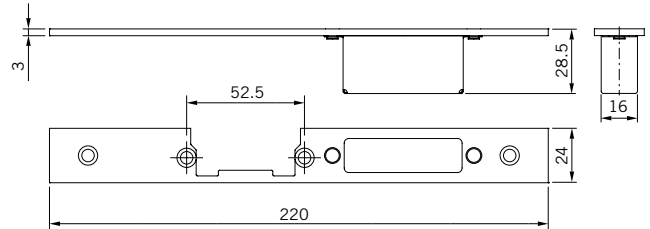

### Stainless steel

Feature	Order No.	EAN	Packaging Unit	Minimal Order	Gross Price per piece EURO
Flat forend 220 x 24 x 3 mm left handed	1100000002981	4021226949696	1		
Flat forend 220 x 24 x 3 mm right handed	1100000002982	4021226949719	1		

## Adjustable closed striking plate for central lock for 840 series

- To be used with mechanical striker 110000003022

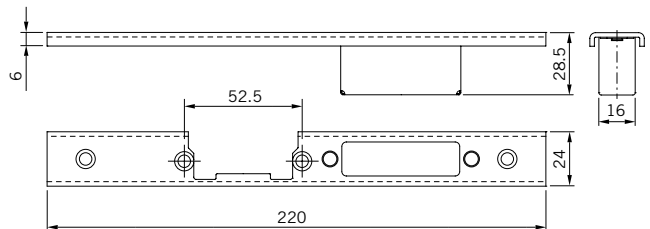

### Stainless steel

Feature	Order No.	EAN	Packaging Unit	Minimal Order	Gross Price per piece EURO
Flat forend 220 x 24 x 6 mm left handed	1100000002983	4021226949733	1		
Flat forend 220 x 24 x 6 mm right handed	1100000002984	4021226949757	1		

Pair of adjustable closed striking plates for top/bottom lateral deadbolts for series 840

- To be used with central striking plates 1100000002981-1100000002982

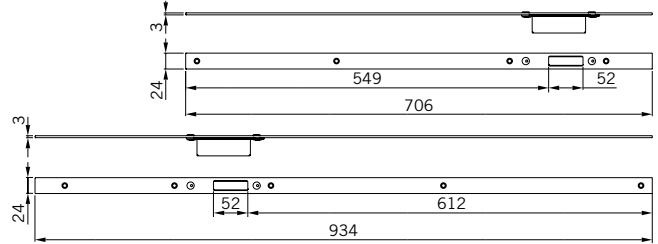

■ Stainless steel

Feature	Order No.	EAN	Packaging Unit	Minimal Order	Gross Price per piece EURO
Flat forend 1860 x 24 x 3 mm	1100000002985	4021226949771	1		

Pair of adjustable closed striking plates for top/bottom lateral deadbolts for series 840

- To be used with central striking plates 1100000002983-1100000002984

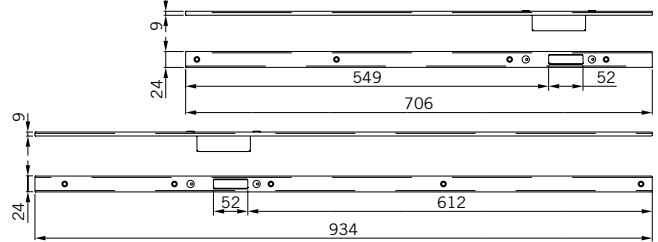

■ Stainless steel

Feature	Order No.	EAN	Packaging Unit	Minimal Order	Gross Price per piece EURO
U-forend 1860 x 24 x 6 mm	1100000002987	4021226949818	1		

Pair of adjustable closed striking plates for top/bottom lateral deadbolts for series 840

- Aluminum
- To be used with central striking plates 1100000002995-1100000002996

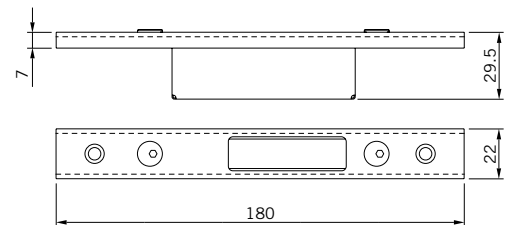

Feature	Order No.	EAN	Packaging Unit	Minimal Order	Gross Price per piece EURO
U-forend 180 x 22 x 7 mm	1100000003001	4021226950098	1		



Pair of adjustable closed striking plates for top/bottom hook bolts for 840 series

- To be used with central striking plates 1100000002825-1100000002826-1100000002829-1100000002830-1100000002981-1100000002982

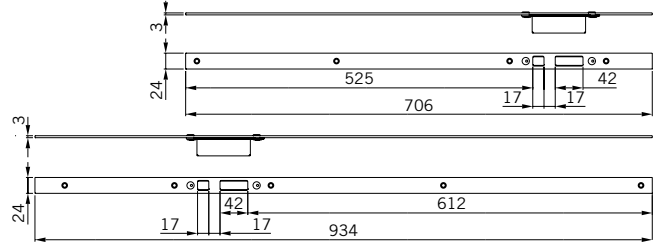

Stainless steel

Feature	Order No.	EAN	Packaging Unit	Minimal Order	Gross Price per piece EURO
Flat forend 24 x 3 x 1860 mm	1100000002833	4021226946770	10		

Pair of adjustable closed striking plates for top/bottom hook bolts for 840 series

- To be used with central striking plates 1100000002827-1100000002828-1100000002831-1100000002832-1100000002983-1100000002984

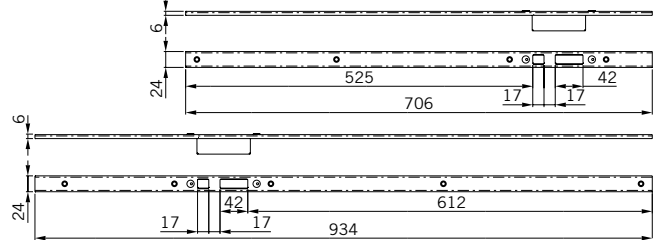

Stainless steel

Feature	Order No.	EAN	Packaging Unit	Minimal Order	Gross Price per piece EURO
U-forend 24 x 3 x 1860 mm	1100000002834	4021226946794	10		

Pair of adjustable closed striking plates for top/bottom lateral hook bolts for series 840

- To be used with central striking plates 1100000002993-1100000002994

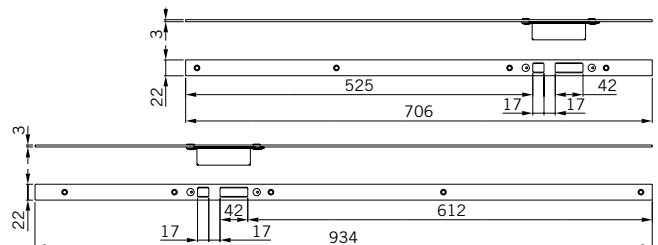

Stainless steel

Feature	Order No.	EAN	Packaging Unit	Minimal Order	Gross Price per piece EURO
Flat forend 1860 x 22 x 3 mm	1100000002997	4021226950012	1		

Pair of adjustable closed striking plates for top/bottom lateral hook bolts for series 840

- Aluminum
- To be used with central striking plates 1100000002995-1100000002996

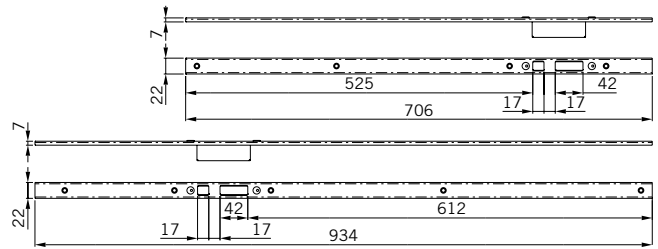

Feature	Order No.	EAN	Packaging Unit	Minimal Order	Gross Price per piece EURO
U-forend 1860 x 22 x 7 mm	1100000002998	4021226950036	1		

Pair of adjustable closed striking plates for top/bottom lateral hook bolts for series 840

- Aluminum
- To be used with central striking plates 1100000002995-1100000002996

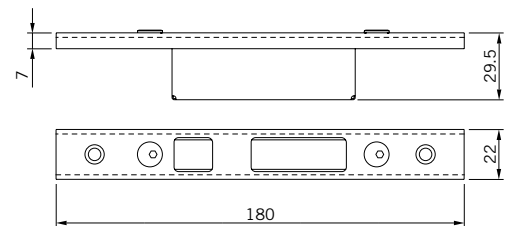

Feature	Order No.	EAN	Packaging Unit	Minimal Order	Gross Price per piece EURO
U-forend 180 x 22 x 7 mm	1100000003002	4021226950111	1		

Adjustable closed striking plate for lateral deadbolts for 840 series

- To be used with central striking plates 1100000002981-1100000002982

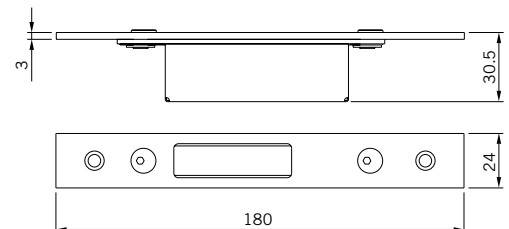

■ Stainless steel

Feature	Order No.	EAN	Packaging Unit	Minimal Order	Gross Price per piece EURO
Flat forend 180 x 24 x 3 mm	1100000002989	4021226949856	1		

### Adjustable closed striking plate for lateral deadbolts for 840 series

- To be used with central striking plates 1100000002981-1100000002984

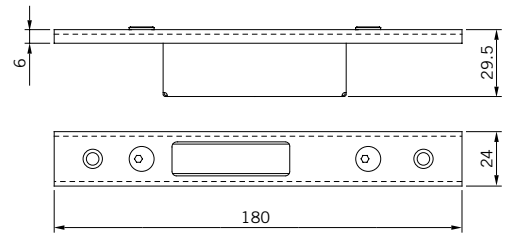

■ Stainless steel

Feature	Order No.	EAN	Packaging Unit	Minimal Order	Gross Price per piece EURO
U-forend 180 x 24 x 6 mm	1100000002991	4021226949894	1		

### Adjustable closed striking plate for hook bolts for 840 series

- To be used with striking plates 1100000002825-1100000002826-1100000002829-1100000002830-1100000002981-1100000002982

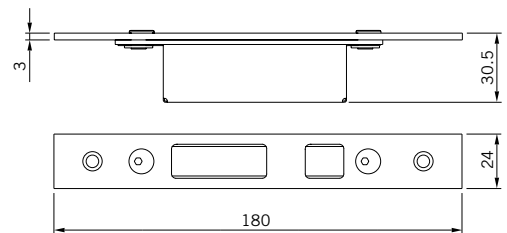

■ Stainless steel

Feature	Order No.	EAN	Packaging Unit	Minimal Order	Gross Price per piece EURO
Flat forend 24 x 3 x 180 mm	1100000002835	4021226946817	10		

### Adjustable closed striking plate for hook bolts for 840 series

- To be used with striking plates 1100000002827-1100000002828-1100000002831-1100000002832-1100000002983-1100000002984

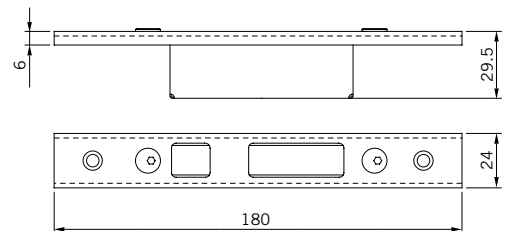

■ Stainless steel

Feature	Order No.	EAN	Packaging Unit	Minimal Order	Gross Price per piece EURO
U-forend 24 x 6 x 180 mm	1100000002836	4021226946831	10		

Adjustable closed striking plate for lateral hook bolts for 840 series

- To be used with central striking plates 1100000002993-1100000002994

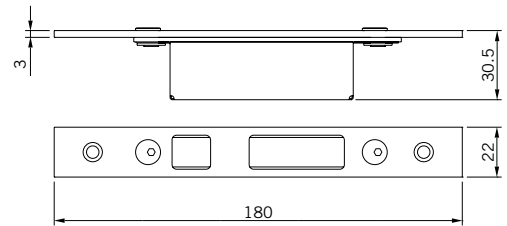

■ Stainless steel

Feature	Order No.	EAN	Packaging Unit	Minimal Order	Gross Price per piece EURO
Flat forend 180 x 22 x 3 mm	1100000003000	4021226950074	1		

Adjustable closed striking plate for central lock for 840 series

- To be used with mechanical striker 1100000003022

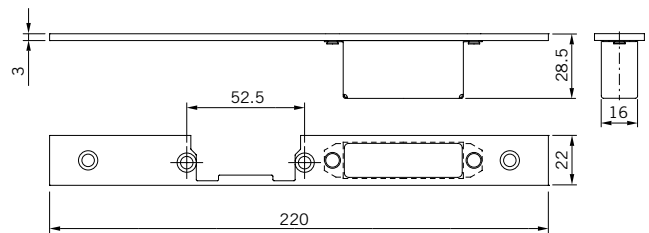

■ Stainless steel

Feature	Order No.	EAN	Packaging Unit	Minimal Order	Gross Price per piece EURO
Flat forend 220 x 22 x 3 mm left handed	1100000002993	4021226949931	1		
Flat forend 220 x 22 x 3 mm right handed	1100000002994	4021226949955	1		

Adjustable closed striking plate for central lock for 840 series

- Aluminum
- To be used with mechanical striker 1100000003022

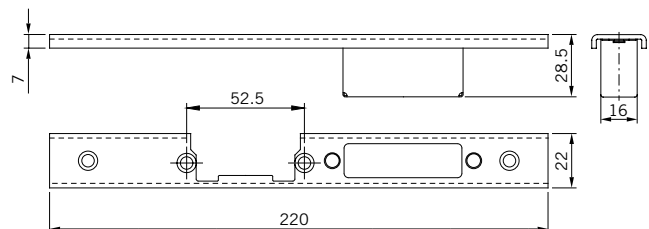

Feature	Order No.	EAN	Packaging Unit	Minimal Order	Gross Price per piece EURO
U-forend 220 x 22 x 7 mm left handed	1100000002995	4021226949979	1		
U-forend 220 x 22 x 7 mm right handed	1100000002996	4021226949993	1		

Closed striking plate for central lock for 840 series

- With latch guide, nylon roller and spacers

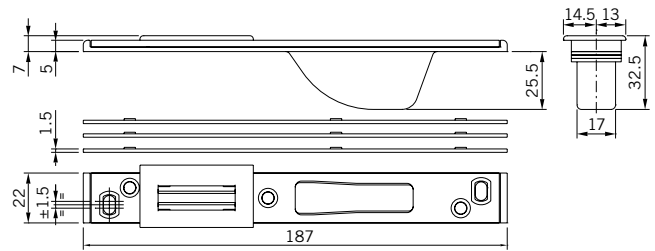

■ Stainless steel

Feature	Order No.	EAN	Packaging Unit	Minimal Order	Gross Price per piece EURO
Flat forend 187 x 22 x 5 mm	1100000003003	4021226950135	10		

Closed striking plate for central lock for 840 series

- With latch guide, nylon roller and spacers

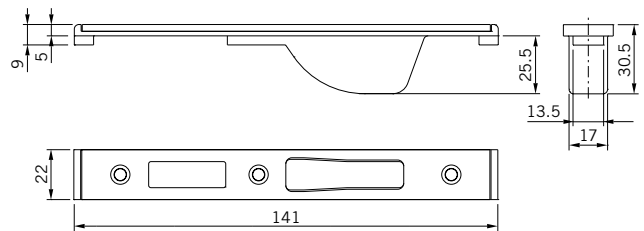

■ Stainless steel

Feature	Order No.	EAN	Packaging Unit	Minimal Order	Gross Price per piece EURO
Flat forend 187 x 22 x 9 mm	1100000003006	4021226950197	10		

Striking plate for central lock for 840 series

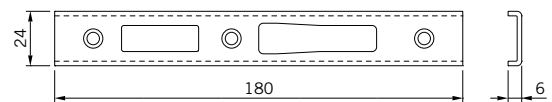

■ Stainless steel

Feature	Order No.	EAN	Packaging Unit	Minimal Order	Gross Price per piece EURO
U-forend 180 x 24 x 6 mm	1100000003009	4021226950258	10		

Striking plate for central lock for 840 series

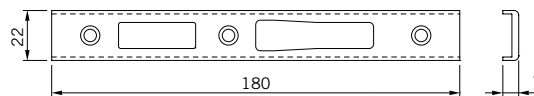

**Black-painted steel**

Feature	Order No.	EAN	Packaging Unit	Minimal Order	Gross Price per piece EURO
U-forend 180 x 22 x 7 mm	1100000003012	4021226950319	10		

Striking plate for central lock for 840 series

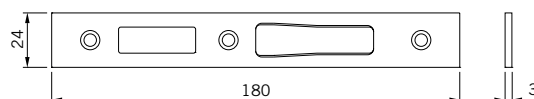

**Stainless steel**

Feature	Order No.	EAN	Packaging Unit	Minimal Order	Gross Price per piece EURO
Flat forend 180 x 24 x 3 mm	1100000003016	4021226950395	10		

Striking plate for central lock for 840 series

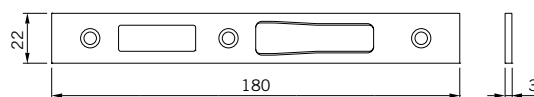

**Stainless steel**

Feature	Order No.	EAN	Packaging Unit	Minimal Order	Gross Price per piece EURO
Flat forend 180 x 22 x 3 mm	1100000003019	4021226950456	10		

Closed striking plate for lateral hook bolts for 840 series

- With spacers

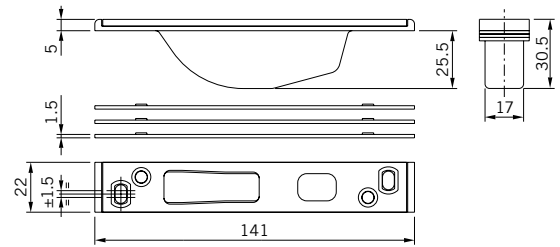

■ Stainless steel

Feature	Order No.	EAN	Packaging Unit	Minimal Order	Gross Price per piece EURO
Flat forend 141 x 22 x 5 mm	1100000003004	4021226950159	10		

Closed striking plate for lateral hook bolts for 840 series

- With spacers

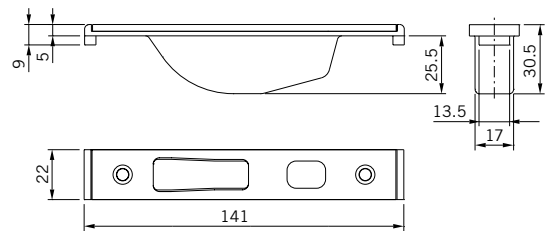

■ Stainless steel

Feature	Order No.	EAN	Packaging Unit	Minimal Order	Gross Price per piece EURO
Flat forend 141 x 22 x 9 mm	1100000003007	4021226950210	10		

Striking plate for lateral hook bolts for 840 series

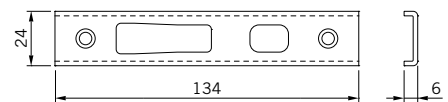

■ Stainless steel

Feature	Order No.	EAN	Packaging Unit	Minimal Order	Gross Price per piece EURO
U-forend 134 x 24 x 6 mm	1100000003010	4021226950272	10		

Striking plate for lateral hook bolts for 840 series

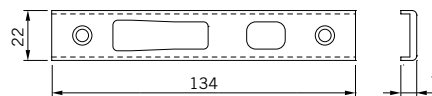

**Black-painted steel**

Feature	Order No.	EAN	Packaging Unit	Minimal Order	Gross Price per piece EURO
U-forend 134 x 22 x 7 mm	1100000003013	4021226950333	10		

Striking plate for lateral hook bolts for 840 series

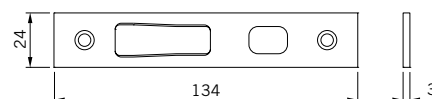

**Stainless steel**

Feature	Order No.	EAN	Packaging Unit	Minimal Order	Gross Price per piece EURO
Flat forend 134 x 24 x 3 mm	1100000003017	4021226950418	10		

Striking plate for lateral hook bolts for 840 series

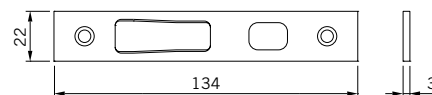

**Stainless steel**

Feature	Order No.	EAN	Packaging Unit	Minimal Order	Gross Price per piece EURO
Flat forend 134 x 22 x 3 mm	1100000003020	4021226950470	10		



Closed striking plate for lateral deadbolts for 840 series

- With spacers

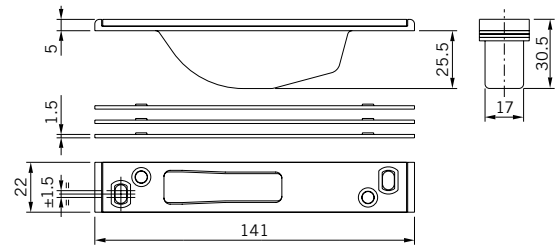

■ Stainless steel

Feature	Order No.	EAN	Packaging Unit	Minimal Order	Gross Price per piece EURO
Flat forend 141 x 22 x 5 mm	1100000003005	4021226950173	10		

Closed striking plate for lateral deadbolts for 840 series

- With spacers

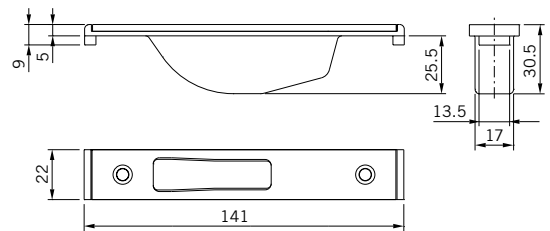

■ Stainless steel

Feature	Order No.	EAN	Packaging Unit	Minimal Order	Gross Price per piece EURO
Flat forend 141 x 22 x 9 mm	1100000003008	4021226950234	10		

Striking plate for lateral deadbolts for 840 series

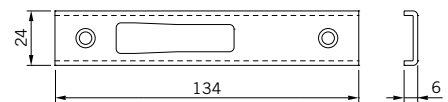

■ Stainless steel

Feature	Order No.	EAN	Packaging Unit	Minimal Order	Gross Price per piece EURO
U-forend 134 x 24 x 6 mm	1100000003011	4021226950296	10		

Striking plate for lateral deadbolts for 840 series

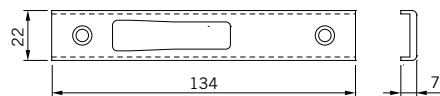

■ Black-painted steel

Feature	Order No.	EAN	Packaging Unit	Minimal Order	Gross Price per piece EURO
U-forend 134 x 22 x 7 mm	1100000003014	4021226950357	10		

Striking plate for lateral deadbolts for 840 series

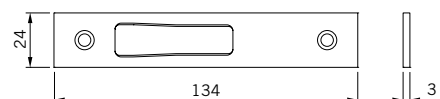

■ Stainless steel

Feature	Order No.	EAN	Packaging Unit	Minimal Order	Gross Price per piece EURO
Flat forend 134 x 24 x 3 mm	1100000003018	4021226950432	10		

Striking plate for lateral deadbolts for 840 series

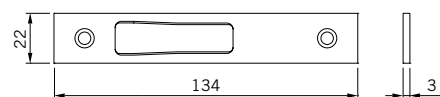

■ Stainless steel

Feature	Order No.	EAN	Packaging Unit	Minimal Order	Gross Price per piece EURO
Flat forend 134 x 22 x 3 mm	1100000003021	4021226950494	10		



# MORTISE LOCK FOR MULTIPOINT LOCKING

---

## 601 series

- Locking: sliding deadbolt; Rods, screwed connection
- Central lock; center distance 85 mm; for operation with europrofile cylinder
- Throw: 20 mm; Follower: 8 mm
- The latch can be replaced by roller or cap
- The lock is equipped with a wheel-cam stopping device if the cylinder is not fitted inside the lock case
- Accessories to be ordered separately:
  - Top/bottom sliding bolts with rods, forend 24 x 3 mm, Top/bottom hook bolts with rods, forend 24 x 3 mm, Roller for central lock 1100000002760, Cap for central lock 1100000002761, Latch bolt for central lock 1100000002762

**R** Reversible latch bolt

**P** 3-point locking

**S** Stainless steel

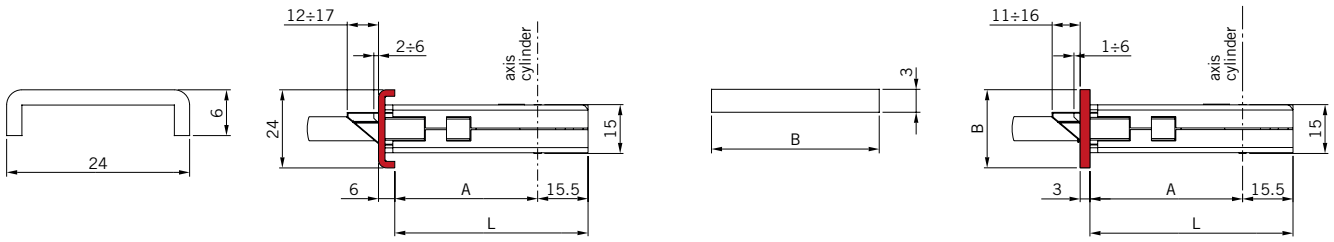

Stainless steel

Backset mm	Forend mm	Ld	Order No.	EAN	Handed	Packaging Unit	Gross Price per piece EURO
25	U-forend 24 mm		1100000002733	4021226944875	non	1	
30	U-forend 24 mm		1100000002734	4021226944899	non	1	
35	U-forend 24 mm		1100000002735	4021226944912	non	1	
40	U-forend 24 mm		1100000002736	4021226944936	non	1	
25	Flat forend (B) 24 mm		1100000002737	4021226944950	non	1	
30	Flat forend (B) 24 mm		1100000002738	4021226944974	non	1	
35	Flat forend (B) 24 mm		1100000002739	4021226944998	non	1	
40	Flat forend (B) 24 mm		1100000002740	4021226945018	non	1	
25	Flat forend (B) 22 mm		1100000002741	4021226945032	non	1	
30	Flat forend (B) 22 mm		1100000002742	4021226945056	non	1	
35	Flat forend (B) 22 mm		1100000002743	4021226945070	non	1	
40	Flat forend (B) 22 mm		1100000002744	4021226945094	non	1	

# TOP/BOTTOM SLIDING BOLTS

## 601 series

- With internal rods
- For locks with backsets of 25, 30, 35 or 40 mm

■ Stainless steel



■ Stainless steel

Feature	Order No.	EAN	Packaging Unit	Minimal Order	Gross Price per piece EURO
Forend 24 x 3	1100000002729	4021226944790	1		
Forend 22 x 3	1100000002730	4021226944813	1		

# TOP/BOTTOM HOOK BOLTS

## 601 series

- With internal rods
- For locks with backsets of 25, 30, 35 or 40 mm



■ Stainless steel

■ Stainless steel

Feature	Order No.	EAN	Packaging Unit	Minimal Order	Gross Price per piece EURO
Forend 24 x 3	1100000002731	4021226944837	1		
Forend 22 x 3	1100000002732	4021226944851	1		

# ACCESSORIES

## Pair of plates with pin

- Pair of plates with pin to connect the lock or lateral lock with screwed connections M4 and external rods

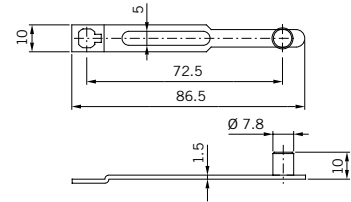

Galvanized steel

Order No.	EAN	Packaging Unit	Minimal Order	Gross Price per piece EURO
1100000003222	4021226954515	10		

## Pair of internal curved rods for 601 and 610 series

- Zinc plate tube  $\varnothing$  8 mm with slotted hole for screwed connection M4
- Two tips  $\varnothing$  8 mm; striker for nylon tip  $\varnothing$  8 mm
- Two noise-proof nylon bushes; one rod connection; two nylon rod guides; two lock fixing plates
- One anti-dust floor socket hole,  $\varnothing$  12 mm
- For locks with screwed rod connection

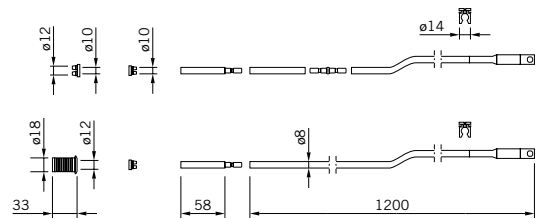

Order No.	EAN	Packaging Unit	Minimal Order	Gross Price per piece EURO
1100000002745	4021226945117	1		

## Pair of internal straight rods for 601 and 610 series

- Zinc plate tube  $\varnothing$  8 mm with slotted hole for screwed connection M4
- Two tips  $\varnothing$  8 mm; striker for nylon tip  $\varnothing$  8 mm
- Two noise-proof nylon bushes; one rod connection; two nylon rod guides; two lock fixing plates
- One anti-dust floor socket, hole  $\varnothing$  12 mm
- For locks with screwed rod connection

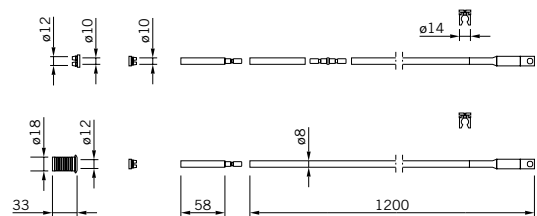

Order No.	EAN	Packaging Unit	Minimal Order	Gross Price per piece EURO
1100000002746	4021226945131	1		



## Threaded connection for rod for 601 and 610 series

- Threaded connection M8 for threaded rod
- To be used with clutch or screwed connection for 3-point locks

Order No.	EAN	Packaging Unit	Minimal Order	Gross Price per piece EURO
1100000002747	4021226945155	20		

# DEADBOLT-LATCH LOCK FOR MULTIPOINT LOCKING 22 MM FOREND

## 610 series

- Locking: rotating deadbolt
- For operation with europrofile cylinder
- Rods, screwed connection
- Forend: 290 x 22 x 3 mm
- Throw: 24 mm
- Separate reversible and adjustable latch (adjustable 10 to 15 mm)
- Latch Locking by key or handle
- Follower: 8 mm
- Pair of forend supports included
- Accessories to be ordered separately:
  - Striking plates
  - Pair of plates used to connect the lock to the external rods 1100000003222
  - Lateral external rods 3-point lateral lock 1100000003051
  - Lateral internal rods 3-point lateral lock 1100000003050
  - Pair of lateral internal rods and accessories 1100000002745
  - Pair of straight internal rods and accessories 1100000002746



- L** Latch locking
- R** Reversible latch bolt
- P** 3-point locking
- Stainless steel

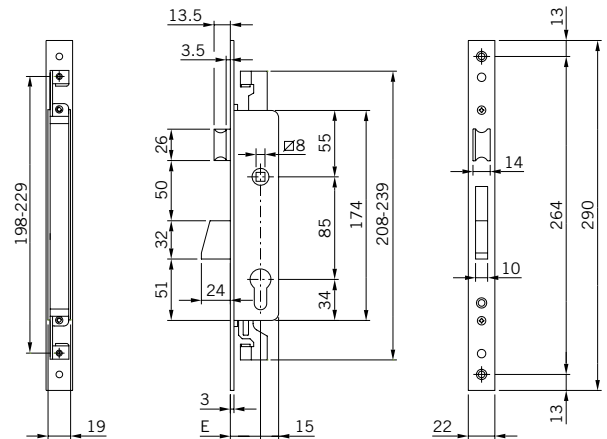

■ Stainless steel

Backset mm	Forend mm	Order No.	EAN	Packaging Unit	Gross Price per piece EURO
25	290 x 22 x 3	1100000003035	4021226950777	1	
30	290 x 22 x 3	1100000003036	4021226950791	1	
35	290 x 22 x 3	1100000003037	4021226950814	1	

# DEADBOLT-LATCH LOCK FOR MULTIPOINT LOCKING 24 MM FOREND

## 610 series

- Locking: rotating deadbolt
- For operation with europrofile cylinder
- Clutch-type rod connection
- Forend: 290 x 24 x 3 mm
- Throw: 24 mm
- Separate reversible and adjustable latch (adjustable 10 to 15 mm)
- Latch Locking by key or handle
- Follower: 8 mm
- Pair of forend supports included
- Accessories to be ordered separately:
  - Striking plates
  - Pair of plates used to connect the lock to the external rods 1100000003255
  - Lateral 3-point locking, internal rods 1100000003098
  - Pair of internal curved and slotted rods  $\varnothing$  8 mm 1100000003251
  - Pair of internal straight and slotted rods  $\varnothing$  8 mm 1100000003252



- L** Latch locking
- R** Reversible latch bolt
- P** 3-point locking
- Stainless steel
- Galvanized steel

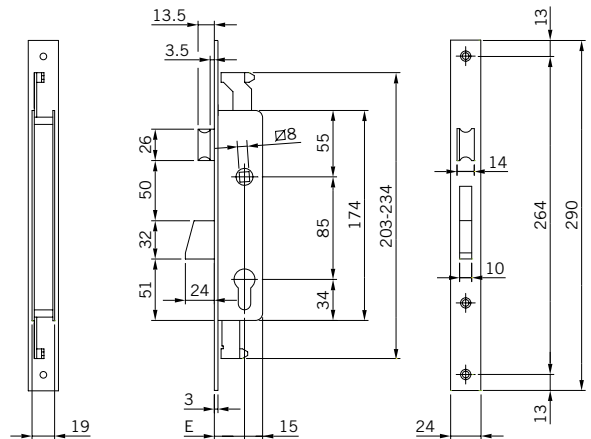

### ■ Stainless steel

Backset mm	Forend mm	Order No.	EAN	Packaging Unit	Gross Price per piece EURO
25	290 x 24 x 3	1100000003070	4021226951477	1	
30	290 x 24 x 3	1100000003071	4021226951491	1	
35	290 x 24 x 3	1100000003072	4021226951514	1	

### ■ Galvanized steel

Backset mm	Forend mm	Order No.	EAN	Packaging Unit	Gross Price per piece EURO
25	290 x 24 x 3	1100000003092	4021226951910	1	
30	290 x 24 x 3	1100000003093	4021226951934	1	
35	290 x 24 x 3	1100000003094	4021226951958	1	

# ROLLER-LATCH LOCK FOR MULTIPOINT LOCKING 22 MM FOREND

## 610 series

- Locking: rotating deadbolt
- For operation with europrofile cylinder
- Rods, screwed connection
- Forend: 290 x 22 x 3 mm
- Throw: 24 mm
- Adjustable roller
- Pair of forend supports included
- Accessories to be ordered separately:
  - Pair of plates used to connect the lock to the external rods 1100000003222
  - Lateral external rods 3-point lock 1100000003051
  - Lateral internal rods 3-point lock 1100000003050
  - Pair of curved internal rods and accessories 1100000002745
  - Pair of straight internal rods and accessories 1100000002746



- R** Reversible latch bolt
- P** 3-point locking
- Stainless steel

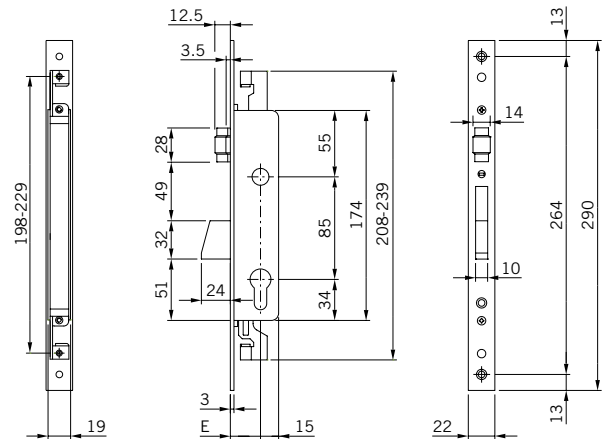

■ Stainless steel

Backset mm	Forend mm	Order No.	EAN	Packaging Unit	Gross Price per piece EURO
25	290 x 22 x 3	1100000003038	4021226950838	1	
30	290 x 22 x 3	1100000003039	4021226950852	1	
35	290 x 22 x 3	1100000003040	4021226950876	1	

# ROLLER-LATCH LOCK FOR MULTI-POINT LOCKING 24 MM FOREND

## 610 series

- Locking: rotating deadbolt
- For operation with europrofile cylinder
- Clutch-type rod connection
- Forend: 290 x 24 x 3 mm
- Throw: 24 mm
- Adjustable roller
- Nylon forend supports
- Accessories to be ordered separately:
- Striking plates
- Pair of plates used to connect the lock to the external rods 1100000003255
- Bolts for lateral 3-point locking, internal rods 1100000003098
- Pair of internal curved and slotted rods  $\varnothing$  8 mm 1100000003251
- Pair of internal straight and slotted rods  $\varnothing$  8 mm 1100000003252



- **P 3-point locking**
- **Stainless steel**

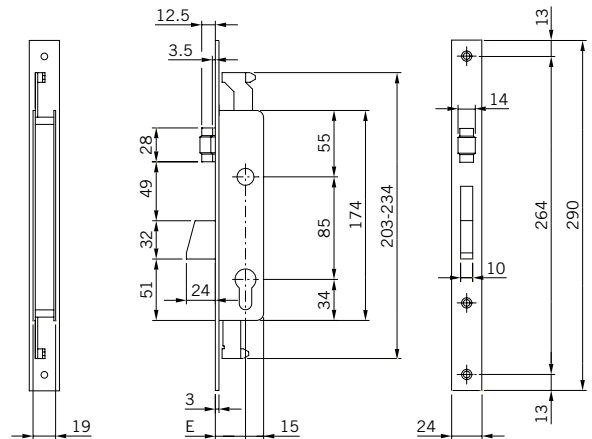

- **Stainless steel**

Backset mm	Forend mm	Order No.	EAN	Packaging Unit	Gross Price per piece EURO
25	290 x 24 x 3	1100000003073	4021226951538	1	
30	290 x 24 x 3	1100000003074	4021226951552	1	
35	290 x 24 x 3	1100000003075	4021226951576	1	

# DEADBOLT LOCK FOR MULTIPOINT LOCKING 22 MM FOREND

## 610 series

- Locking: rotating deadbolt
- For operation with europrofile cylinder
- Rods, screwed connection
- Forend: 290 x 22 x 3 mm
- Throw: 24 mm
- Pair of forend supports
- Accessories to be ordered separately:
  - Pair of plates used to connect the lock to the external rods 1100000003222
  - Lateral external rods 3-point lock 1100000003051
  - Lateral internal rods 3-point lock 1100000003050
  - Pair of curved internal rods and accessories 1100000002745
  - Pair of straight internal rods and accessories 1100000002746



- **P 3-point locking**
- **Stainless steel**

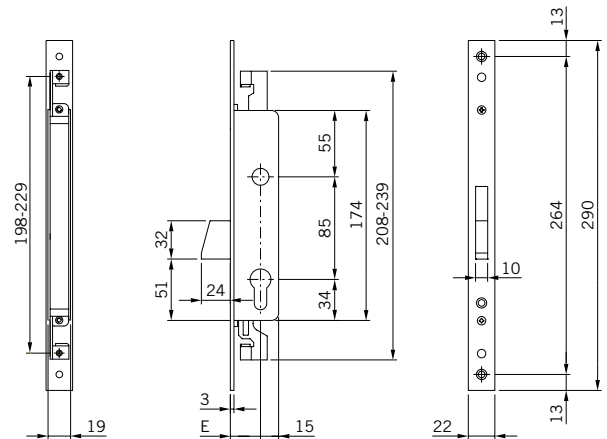

- **Stainless steel**

Backset mm	Forend mm	Order No.	EAN	Packaging Unit	Gross Price per piece EURO
25	290 x 22 x 3	1100000003041	4021226950890	1	
30	290 x 22 x 3	1100000003042	4021226950913	1	
35	290 x 22 x 3	1100000003043	4021226950937	1	

# DEADBOLT LOCK FOR MULTIPOINT LOCKING 24 MM FOREND

## 610 series

- Locking: rotating deadbolt
- For operation with europrofile cylinder
- Clutch-type rod connection
- Forend: 290 x 24 x 3 mm
- Throw: 24 mm
- Pair of forend supports
- Accessories to be ordered separately:
  - Striking plates
  - Pair of plates used to connect the lock to the external rods 1100000003255
  - Bolts for lateral 3-point locking, internal rods 1100000003098
  - Pair of internal curved and slotted rods  $\varnothing$  8 mm 1100000003251
  - Pair of internal straight and slotted rods  $\varnothing$  8 mm 1100000003252



- H** Rotating hook bolt
- P** 3-point locking
- Stainless steel
- Galvanized steel

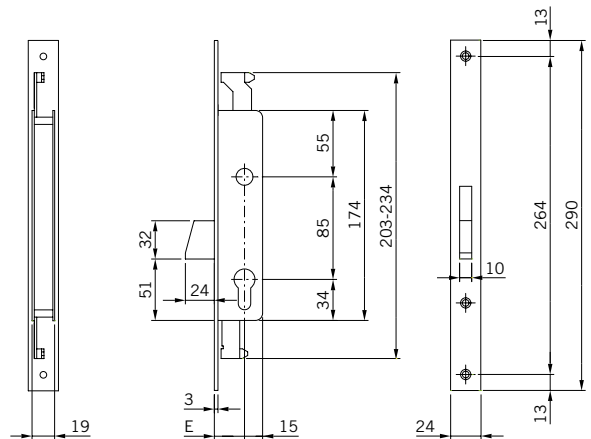

### ■ Stainless steel

Backset mm	Forend mm	Order No.	EAN	Packaging Unit	Gross Price per piece EURO
25	290 x 24 x 3	1100000003076	4021226951590	1	
30	290 x 24 x 3	1100000003077	4021226951613	1	
35	290 x 24 x 3	1100000003078	4021226951637	1	

### ■ Galvanized steel

Backset mm	Forend mm	Order No.	EAN	Packaging Unit	Gross Price per piece EURO
25	290 x 24 x 3	1100000003095	4021226951972	1	
30	290 x 24 x 3	1100000003096	4021226951996	1	
35	290 x 24 x 3	1100000003097	4021226952016	1	

# HOOK LOCK FOR MULTIPOINT LOCKING 22 MM FOREND

## 610 series

- Locking: rotating deadbolt
- Central lock; center distance 85 mm; for operation with europrofile cylinder
- Rods, screwed connection
- Forend: 290 x 22 x 3 mm
- Throw: 24 mm
- Pair of forend supports
- Accessories to be ordered separately:
  - Pair of plates used to connect the lock to external rods 1100000003222
  - Bolts for external rods 3-point lateral lock 1100000003051
  - Lateral internal rods 3-point lock 1100000003050
  - Pair of curved internal rods and accessories 1100000002745
  - Pair of straight internal rods and accessories 1100000002746



- **P 2-point locking**
- **Stainless steel**

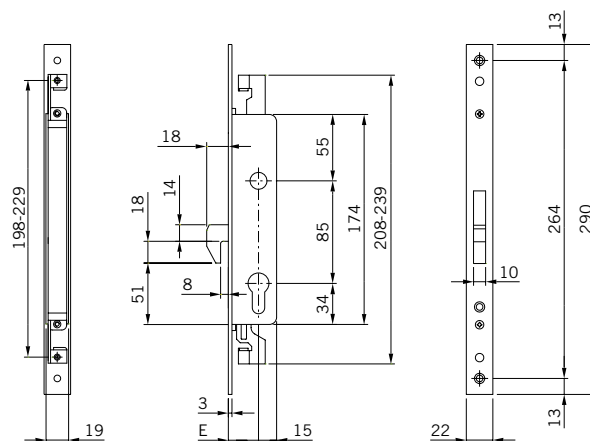

- **Stainless steel**

Backset mm	Forend mm	Order No.	EAN	Packaging Unit	Gross Price per piece EURO
25	290 x 22 x 3	1100000003044	4021226950951	1	
30	290 x 22 x 3	1100000003045	4021226950975	1	
35	290 x 22 x 3	1100000003046	4021226950999	1	



# HOOK LOCK FOR MULTIPOINT LOCKING 24 MM FOREND

## 610 series

- Locking: rotating hook
- Central lock; center distance 85 mm; for operation with europrofile cylinder
- Clutch-type rod connection
- Forend: 290 x 24 x 3 mm
- Throw: 18 mm; clearance 8 mm
- Pair of forend supports
- Accessories to be ordered separately:
  - Striking plates
  - Pair of plates used to connect the lock to external rods 1100000003255
  - Bolts for lateral 3-point locking, internal rods 1100000003098
  - Pair of internal curved and slotted rods  $\varnothing$  8 mm 1100000003251
  - Pair of internal straight and slotted rods  $\varnothing$  8 mm 1100000003252



- P** 3-point locking
- Stainless steel

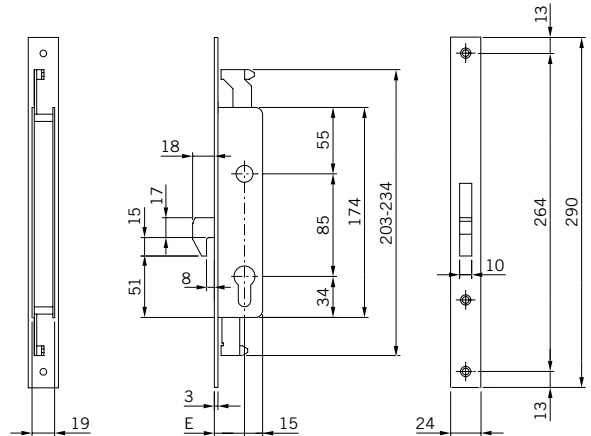

Stainless steel

Backset mm	Forend mm	Order No.	EAN	Packaging Unit	Gross Price per piece EURO
25	290 x 24 x 3	1100000003079	4021226951651	1	
30	290 x 24 x 3	1100000003080	4021226951675	1	
35	290 x 24 x 3	1100000003081	4021226951699	1	

# LOCK FOR MULTIPOINT LOCKING 22 MM FOREND

## 610 series

- Locking: double top/bottom locking
- For operation with europrofile cylinder
- Rods, screwed connection
- Forend: 290 x 22 x 3 mm
- Pair of forend supports
- Accessories to be ordered separately:
- Striking plates
- Pair of plates used to connect the lock to the external rods 1100000003222
- Bolts for external rods 2-point lateral lock 1100000003051
- Bolts for internal rods 2-point lateral lock 1100000003050
- Pair of curved internal rods and accessories 1100000002745
- Pair of straight internal rods and accessories 1100000002746



- **P** 2-point locking
- Stainless steel

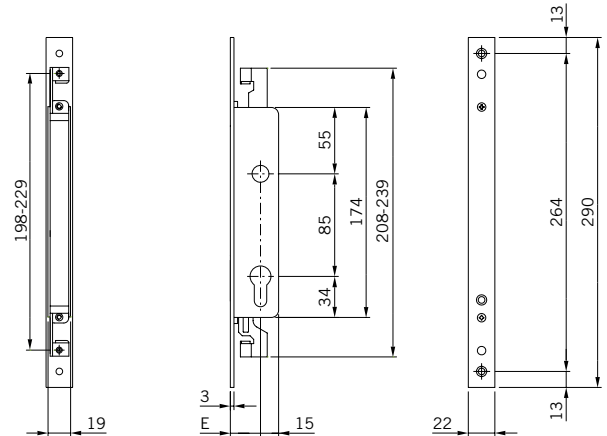

■ Stainless steel

Backset mm	Forend mm	Order No.	EAN	Packaging Unit	Gross Price per piece EURO
25	290 x 22 x 3	1100000003047	4021226951019	1	
30	290 x 22 x 3	1100000003048	4021226951033	1	
35	290 x 22 x 3	1100000003049	4021226951057	1	

# LOCK FOR MULTIPOINT LOCKING 24 MM FOREND

## 610 series

- Locking: double top/bottom locking
- For operation with europrofile cylinder
- Clutch-type rod connection
- Forend: 290 x 24 x 3 mm
- Pair of forend supports
- Accessories to be ordered separately:
  - Striking plates
  - Pair of plates used to connect the lock to external rods 1100000003255
  - Bolts for lateral 2-point locking, internal rods 1100000003098
  - Pair of internal curved and slotted rods  $\varnothing$  8 mm 1100000003251
  - Pair of internal straight and slotted rods  $\varnothing$  8 mm 1100000003252



- P** 2-point locking
- Stainless steel

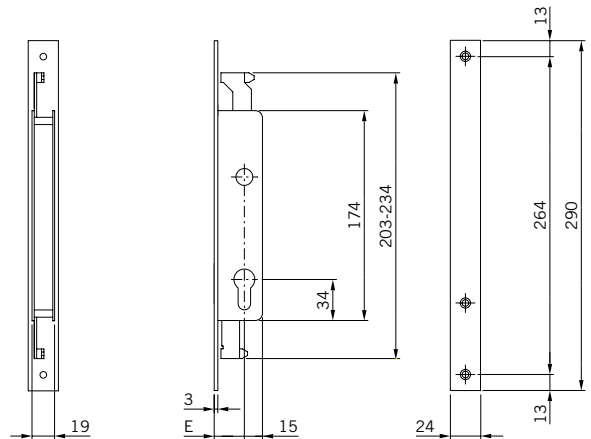

- Stainless steel

Backset mm	Forend mm	Order No.	EAN	Packaging Unit	Gross Price per piece EURO
25	290 x 24 x 3	1100000003082	4021226951712	1	
30	290 x 24 x 3	1100000003083	4021226951736	1	
35	290 x 24 x 3	1100000003084	4021226951750	1	

# LATERAL LOCKING, SCREWED CONNECTION

## 610 series

- For top/bottom locking
- Internal rods to be used with locks with screwed connection
- Locking: rotating deadbolt
- Throw: 24 mm
- Forend 190 x 22 x 3 mm
- With internal rods, 2 pairs of nylon spacers and rod guiding nylon bushes



- **P** 3-point locking
- Stainless steel

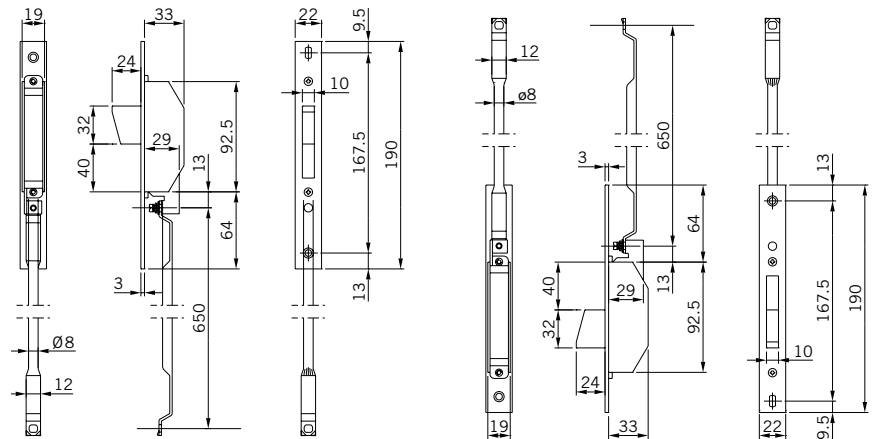

■ Stainless steel

Backset	Forend	Handed	Order No.	EAN	Packaging Unit	Gross Price per piece
mm	mm					EURO
	190 x 22 x 3	non	1100000003050	4021226951071	1	

# LATERAL LOCKING, SCREWED CONNECTION

## 610 series

- For top/bottom locking
- External rods to be used with locks with screwed connection
- Locking: rotating deadbolt
- Throw: 24 mm
- Forend 190 x 22 x 3 mm
- Without internal rods
- With 2 pairs of nylon spacers and rod guiding nylon bushes



- **P** 3-point locking
- Stainless steel

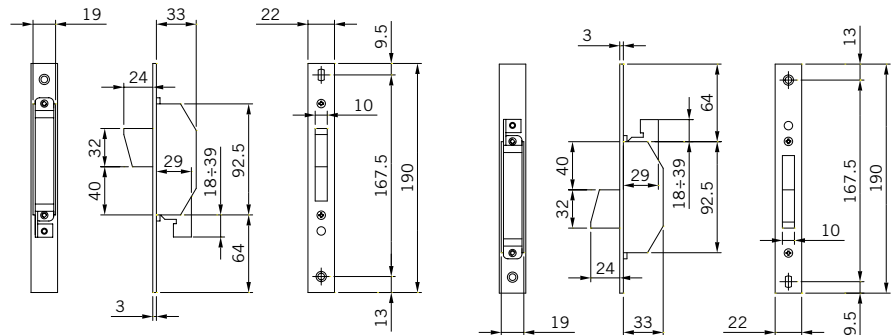

■ Stainless steel

Backset	Forend	Handed	Order No.	EAN	Packaging Unit	Gross Price per piece
mm	mm					EURO
	190 x 22 x 3	non	1100000003051	4021226951095	1	

# LATERAL LOCKING, CLUTCH CONNECTION

## 610 series

- For top/bottom locking
- Internal rods to be used with locks with clutch connection
- Locking: rotating deadbolt
- Throw: 24 mm
- Forend 160 x 24 x 3 mm
- With internal rods, rod guiding pins and screws with roses



- **P 3-point locking**
- **Stainless steel**

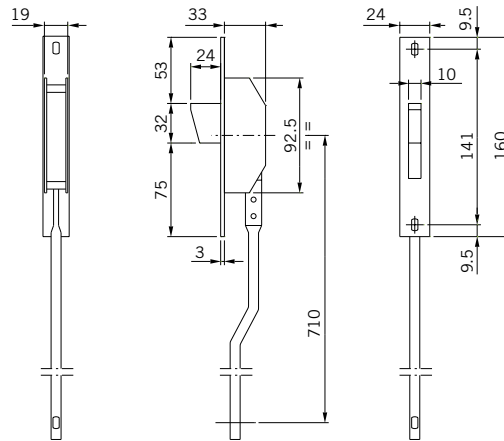

- **Stainless steel**

Backset	Forend	Handed	Order No.	EAN	Packaging Unit	Gross Price per piece
mm	mm					EURO
	160 x 24 x 3	non	1100000003085	4021226951774	1	

# LATERAL LOCKING, CLUTCH CONNECTION

## 610 series

- For top/bottom locking
- Internal rods to be used with locks with clutch connection
- Locking: rotating deadbolt
- Throw: 24 mm
- Forend 160 x 24 x 3 mm
- With internal rods, rod guiding pins and screws with roses



- **P** 3-point locking
- Galvanized steel

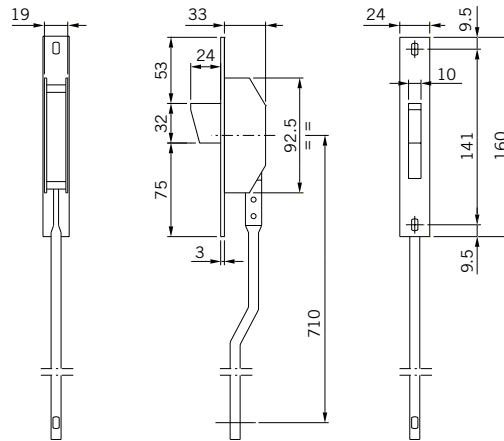

- Galvanized steel

Backset	Forend	Handed	Order No.	EAN	Packaging Unit	Gross Price per piece
mm	mm					EURO
	160 x 24 x 3	non	1100000003098	4021226952030	1	

# DEADBOLT LOCK FOR MULTIPOINT LOCKING 24 MM FOREND

## 611 series

- For shutters
- Locking: rotating deadbolt
- Center distance 85 mm; for operation with europrofile cylinder
- Pre-assembled M8 rod connection; travel range 15 mm
- Forend: 290 x 24 x 3 mm
- Throw: 24 mm
- Accessories to be ordered separately:
  - 2 tips Ø 10 mm for threaded rods M8 1100000003256
  - Pins, tips and rod guiding plates for Ø 8 mm rods 1100000003257
  - Striking plate in stainless steel 1100000003153



- P** 3-point locking
- Stainless steel
- Galvanized steel

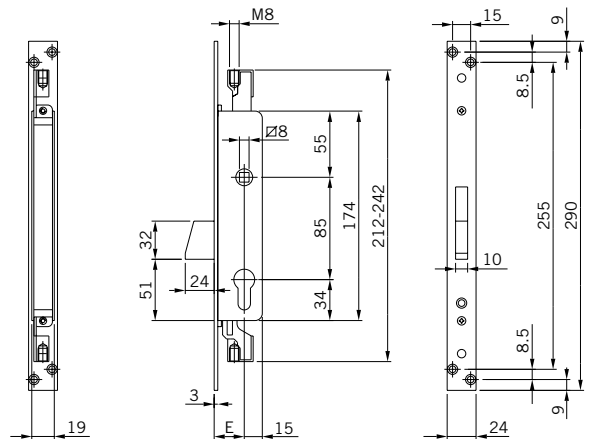

### ■ Stainless steel

Backset mm	Forend mm	Order No.	EAN	Packaging Unit	Gross Price per piece EURO
25	290 x 24 x 3	1100000003099	4021226952054	1	
30	290 x 24 x 3	1100000003100	4021226952078	1	
35	290 x 24 x 3	1100000003101	4021226952092	1	

### ■ Galvanized steel

Backset mm	Forend mm	Order No.	EAN	Packaging Unit	Gross Price per piece EURO
25	290 x 24 x 3	1100000003108	4021226952238	1	
30	290 x 24 x 3	1100000003109	4021226952252	1	
35	290 x 24 x 3	1100000003110	4021226952276	1	



# HOOK LOCK FOR MULTIPOINT LOCKING 24 MM FOREND

## 611 series

- For shutters
- Locking: rotating hook
- Center distance 85 mm; for operation with europrofile cylinder
- Pre-assembled M8 rod connection; travel range 15 mm
- Forend: 290 x 24 x 3 mm
- Throw: 18 mm
- Accessories to be ordered separately:
  - 2 tips Ø 10 mm for threaded rods M8 1100000003256
  - Pins, tips and rod guiding plates for Ø 8 mm rods 1100000003257
  - Striking plate in stainless steel 1100000003153



- H** Rotating hook bolt
- P** 3-point locking
- Stainless steel
- Galvanized steel

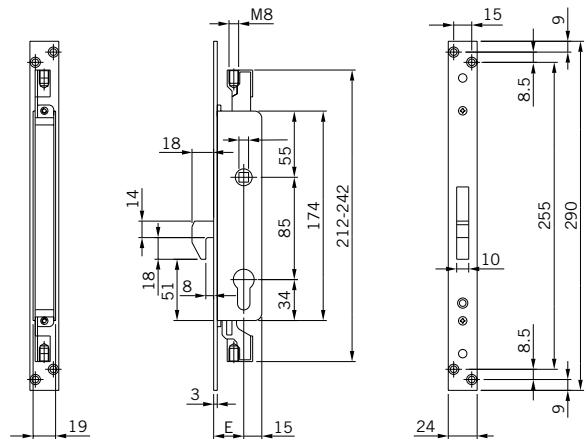

### Stainless steel

Backset mm	Forend mm	Order No.	EAN	Packaging Unit	Gross Price per piece EURO
25	290 x 24 x 3	1100000003102	4021226952115	1	
30	290 x 24 x 3	1100000003103	4021226952139	1	
35	290 x 24 x 3	1100000003104	4021226952153	1	

### Galvanized steel

Backset mm	Forend mm	Order No.	EAN	Packaging Unit	Gross Price per piece EURO
25	290 x 24 x 3	1100000003111	4021226952290	1	
30	290 x 24 x 3	1100000003112	4021226952313	1	
35	290 x 24 x 3	1100000003113	4021226952337	1	

# LOCK FOR MULTIPOINT LOCKING 24 MM FOREND

## 611 series

- Fur shutters
- Locking: double top/bottom locking
- Center distance 85 mm; for operation with europrofile cylinder
- Pre-assembled M8 rod connection; travel range 15 mm
- Forend: 290 x 24 x 3 mm
- Pair of forend supports
- Accessories to be ordered separately:
  - 2 tips Ø 10 mm for threaded rods M8 1100000003256
  - Pins, tips and rod guiding plates for Ø 8 mm rods 1100000003257
  - Striking plate in stainless steel 1100000003153



- P** 2-point locking
- Stainless steel
- Galvanized steel

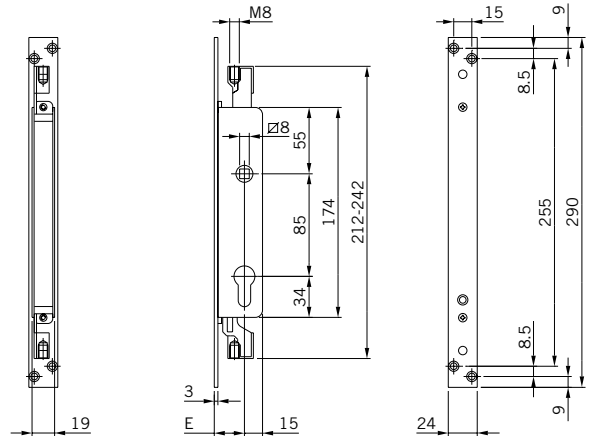

### ■ Stainless steel

Backset mm	Forend mm	Order No.	EAN	Packaging Unit	Gross Price per piece EURO
25	290 x 24 x 3	1100000003105	4021226952177	1	
30	290 x 24 x 3	1100000003106	4021226952191	1	
35	290 x 24 x 3	1100000003107	4021226952214	1	

### ■ Galvanized steel

Backset mm	Forend mm	Order No.	EAN	Packaging Unit	Gross Price per piece EURO
25	290 x 24 x 3	1100000003114	4021226952351	1	
30	290 x 24 x 3	1100000003115	4021226952375	1	
35	290 x 24 x 3	1100000003116	4021226952399	1	

# STRIKING PLATES

Closed reversible striking plate for 603/610/611 series

- To be used with electric strikers
- With nylon case

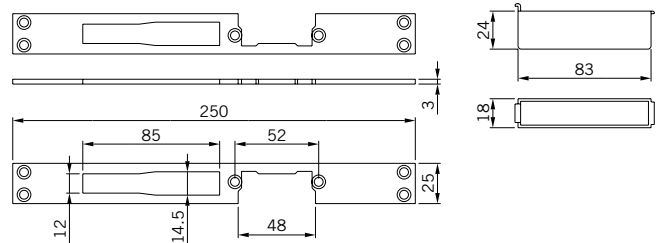

■ Satin stainless steel

Feature	Order No.	EAN	Packaging Unit	Minimal Order	Gross Price per piece EURO
Flat forend 250 x 25 x 3 mm	1100000003260	4021226955277	1		

Closed right-hand striking plate for 603/610/611 series

- To be used with electric strikers
- With nylon caps and case

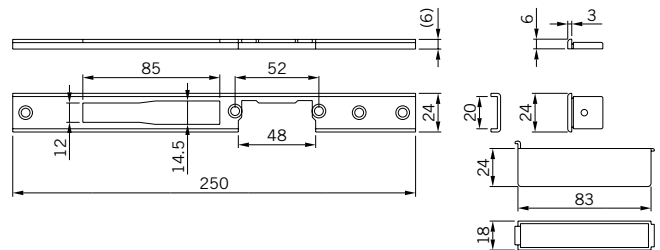

■ Satin stainless steel

Feature	Order No.	EAN	Packaging Unit	Minimal Order	Gross Price per piece EURO
U-forend 250 x 24 x 6 mm	1100000003261	4021226955291	1		

Closed left-hand striking plate for 603/610/611 series

- To be used with electric strikers
- With nylon caps and case

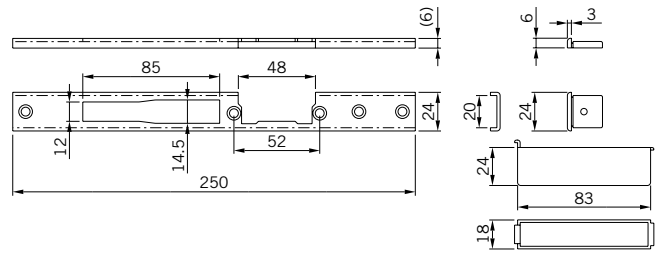

■ Satin stainless steel

Feature	Order No.	EAN	Packaging Unit	Minimal Order	Gross Price per piece EURO
U-forend 250 x 24 x 6 mm	1100000003262	4021226955314	1		

Reversible striking plate for locks with latch for 603/610/611 series

- To be used with electric strikers

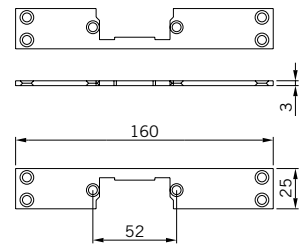

■ Satin stainless steel

Feature	Order No.	EAN	Packaging Unit	Minimal Order	Gross Price per piece EURO
Flat forend 160 x 25 x 3 mm	1100000003263	4021226955338	1		

Reversible striking plate for locks with latch

- To be used with electric strikers
- With cap

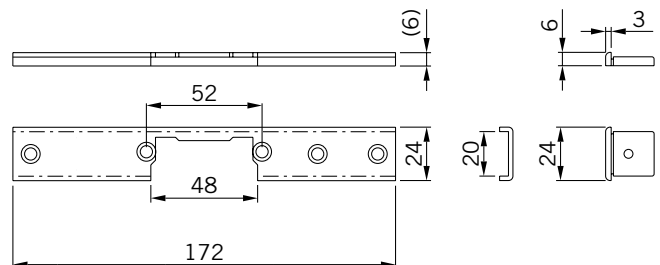

■ Satin stainless steel

Feature	Order No.	EAN	Packaging Unit	Minimal Order	Gross Price per piece EURO
U-forend 172 x 24 x 6 mm	1100000003264	4021226955352	1		

### Forend

- To be used with electric strikers
- With nylon case

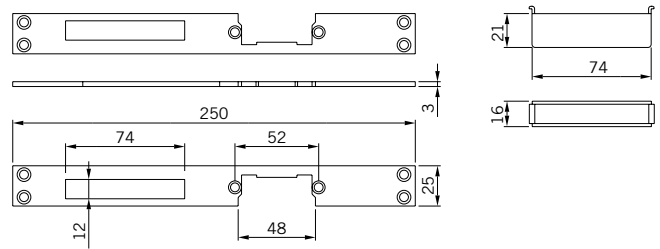

**Satin stainless steel**

Feature	Order No.	EAN	Packaging Unit	Minimal Order	Gross Price per piece EURO
Flat forend 250 x 30.5 x 25 mm	1100000003265	4021226955376	1		

### Forend

- To be used with electric strikers
- With nylon case

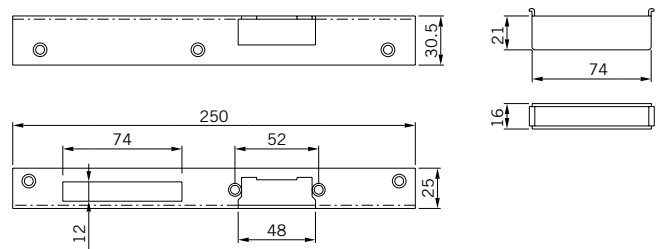

**Gold-painted**

Feature	Order No.	EAN	Packaging Unit	Minimal Order	Gross Price per piece EURO
Flat forend 250 x 25 x 3 mm	1100000003266	4021226955390	1		

### Forend

- To be used with electric strikers
- With nylon case

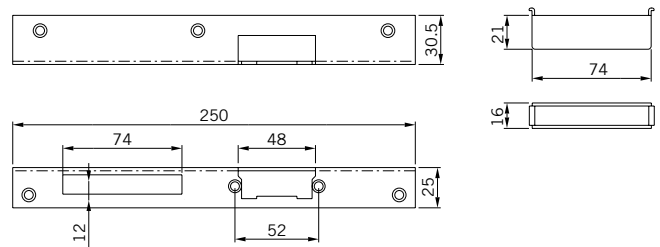

**Gold-painted**

Feature	Order No.	EAN	Packaging Unit	Minimal Order	Gross Price per piece EURO
Flat forend 250 x 25 x 3 mm	1100000003267	4021226955413	1		

Adjustable closed striking plate for central lock for 820/821/830/831/840/603/610/611 series

- Vertical adjustment 7 to 12 mm and horizontal adjustment  $\pm 2$  mm

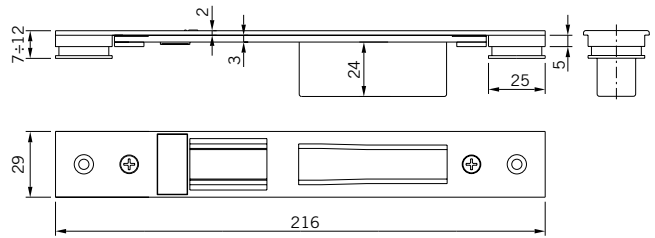

**Black-painted steel**

Feature	Order No.	EAN	Packaging Unit	Minimal Order	Gross Price per piece EURO
Flat forend 216 x 29 mm	1100000003135	4021226952771	10		

Adjustable closed striking plate for central lock for 820/821/830/831/840/603/610/611 series

- Vertical adjustment through threaded plates and horizontal adjustment  $\pm 9$  mm

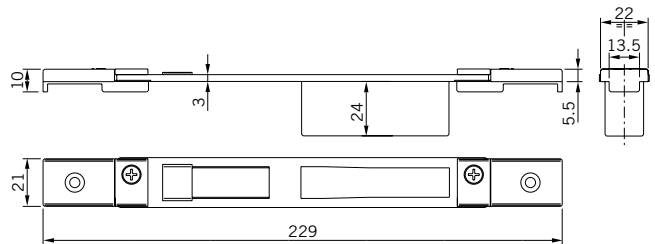

**Black-painted steel**

Feature	Order No.	EAN	Packaging Unit	Minimal Order	Gross Price per piece EURO
Flat forend 229 x 22 mm	1100000003136	4021226952795	10		

Adjustable closed striking plate for central lock for 820/821/830/831/840/603/610/611 series

- Horizontal adjustment  $\pm 9$  mm

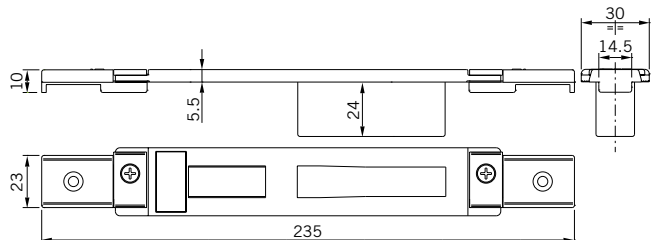

**Black-painted steel**

Feature	Order No.	EAN	Packaging Unit	Minimal Order	Gross Price per piece EURO
Flat forend 235 x 30 mm	1100000003137	4021226952818	10		

Adjustable closed striking plate for central lock for 820/821/830/831/840/603/610/611 series

- Horizontal adjustment  $\pm 9$  mm

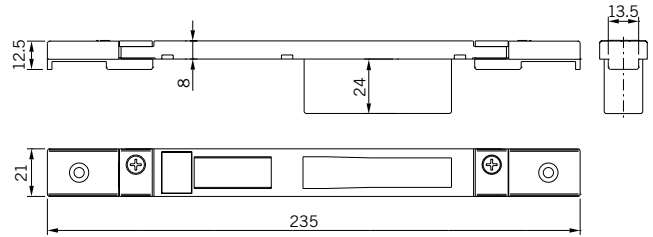

■ Black-painted steel

Feature	Order No.	EAN	Packaging Unit	Minimal Order	Gross Price per piece EURO
Flat forend 235 x 21 mm	1100000003138	4021226952832	10		

Adjustable closed striking plate for central lock for 820/821/830/831/840/603/610/611 series

- Horizontal adjustment  $\pm 13$  mm

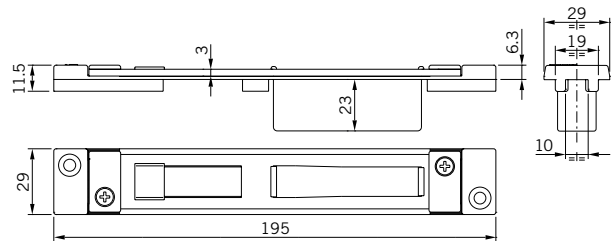

■ Black-painted steel

Feature	Order No.	EAN	Packaging Unit	Minimal Order	Gross Price per piece EURO
Flat forend 195 x 29 mm	1100000003139	4021226952856	10		

Adjustable closed striking plate for lock for deadbolts and lateral bolts only

- Vertical adjustment 7 to 12 mm and horizontal adjustment  $\pm 2$  mm

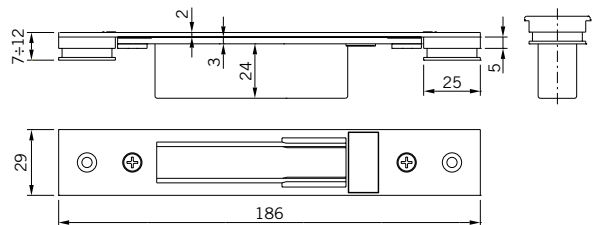

■ Black-painted steel

Feature	Order No.	EAN	Packaging Unit	Minimal Order	Gross Price per piece EURO
Flat forend 186 x 29 mm	1100000003140	4021226952870	10		

Adjustable closed striking plate for lock for deadbolts and lateral bolts only

- Vertical adjustment 7 to 12 mm and horizontal adjustment  $\pm 2$  mm

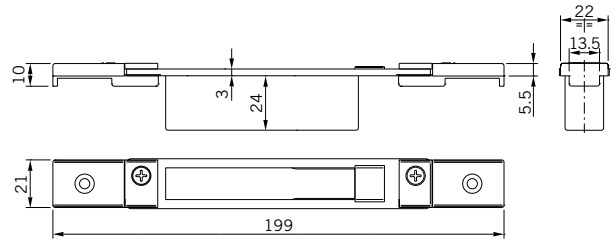

Black-painted steel

Feature	Order No.	EAN	Packaging Unit	Minimal Order	Gross Price per piece EURO
Flat forend 186 x 29 mm	1100000003141	4021226952894	10		

Adjustable closed striking plate for lock for deadbolts and lateral bolts only

- Horizontal adjustment  $\pm 9$  mm

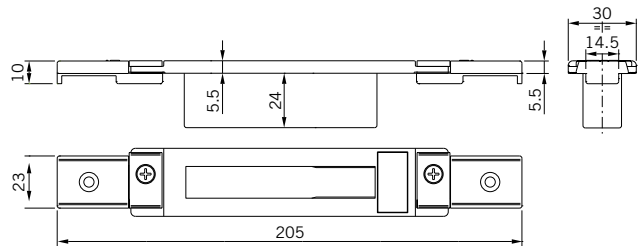

Black-painted steel

Feature	Order No.	EAN	Packaging Unit	Minimal Order	Gross Price per piece EURO
Flat forend 205 x 30 mm	1100000003142	4021226952917	10		

Adjustable closed striking plate for lock for deadbolts and lateral bolts only

- Horizontal adjustment  $\pm 9$  mm

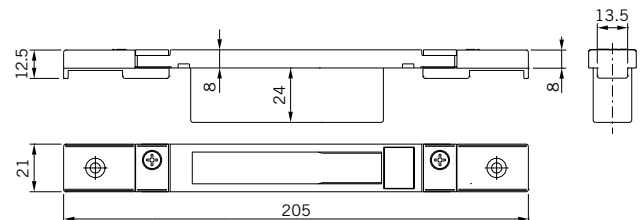

Black-painted steel

Feature	Order No.	EAN	Packaging Unit	Minimal Order	Gross Price per piece EURO
Flat forend 205 x 21 mm	1100000003143	4021226952931	10		



Adjustable closed striking plate for lock for deadbolts and lateral bolts only

- Horizontal adjustment  $\pm 13$  mm

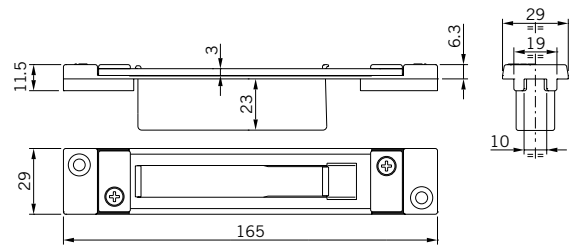

■ Black-painted steel

Feature	Order No.	EAN	Packaging Unit	Minimal Order	Gross Price per piece EURO
Flat forend 165 x 29 mm	1100000003144	4021226952955	10		

Adjustable closed striking plate for lock for lateral hook bolts

- Vertical adjustment 7 to 12 mm and horizontal adjustment  $\pm 2$  mm

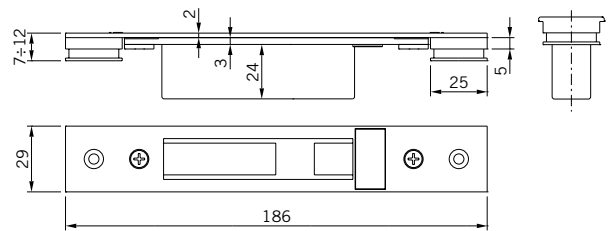

■ Black-painted steel

Feature	Order No.	EAN	Packaging Unit	Minimal Order	Gross Price per piece EURO
Flat forend 186 x 29 mm	1100000003145	4021226952979	10		

Adjustable closed striking plate for lock for lateral hook bolts

- Horizontal adjustment  $\pm 9$  mm

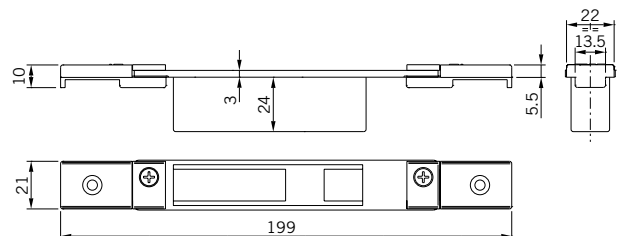

■ Black-painted steel

Feature	Order No.	EAN	Packaging Unit	Minimal Order	Gross Price per piece EURO
Flat forend 197 x 21 mm	1100000003146	4021226952993	10		

Adjustable closed striking plate for lock for lateral hook bolts

- Horizontal adjustment  $\pm 13$  mm

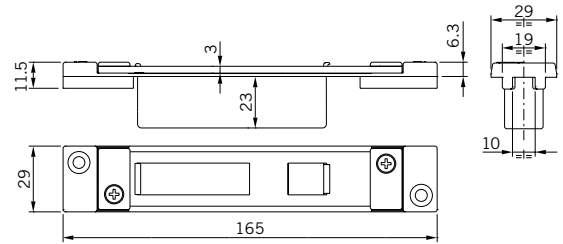

■ Black-painted steel

Feature	Order No.	EAN	Packaging Unit	Minimal Order	Gross Price per piece EURO
Flat forend 165 x 29 mm	1100000003147	4021226953013	10		

Striking plate for multipoint locks for double-leaf doors

- With tips, with 3 deadbolt seats, same length as forend
- Built-in top/bottom tips
- Zamak upper striker
- Stainless steel floor keep

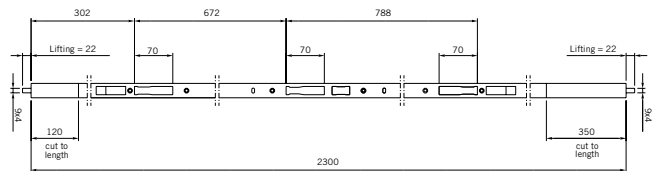

■ Black-painted aluminum

Feature	Order No.	EAN	Packaging Unit	Minimal Order	Gross Price per piece EURO
U-forend 22.5 x 10 mm	1100000003148	4021226953037	1		
U-forend 20.5 x 12 mm	1100000003149	4021226953051	1		

### Striking plate for multipoint locks for single-leaf doors

- Without tips, with 3 deadbolt seats, same length as forend

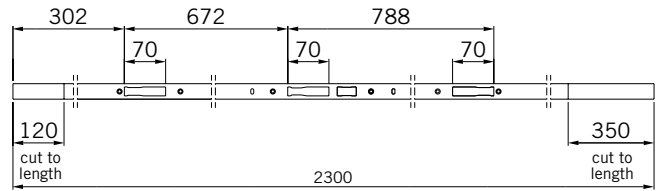

**Black-painted aluminum**

Feature	Order No.	EAN	Packaging Unit	Minimal Order	Gross Price per piece EURO
U-forend 22.5 x 10 mm	1100000003150	4021226953075	1		
U-forend 20.5 x 12 mm	1100000003151	4021226953099	1		
Flat forend 24 x 3 mm	1100000003152	4021226953112	1		

### Striking plate for lock for deadbolts and lateral bolts for 603/610/611 series

- For european cylinder frames and two-piece rail frames

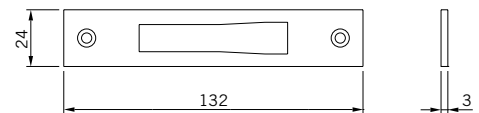

**Galvanized steel**

Feature	Order No.	EAN	Packaging Unit	Minimal Order	Gross Price per piece EURO
Flat forend 132 x 24 x 3 mm	1100000003154	4021226953150	10		

### Striking plate for lock for deadbolts and lateral bolts for 603/610/611 series

- For european cylinder frames and two-piece rail frames

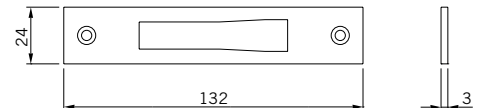

**Stainless steel**

Feature	Order No.	EAN	Packaging Unit	Minimal Order	Gross Price per piece EURO
Flat forend 132 x 24 x 3 mm	1100000003153	4021226953136	10		

Striking plate for lock for deadbolts and lateral bolts for 603/610/611 series

- For european cylinder frames and two-piece rail frames

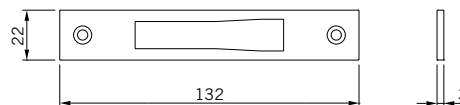

■ Stainless steel

Feature	Order No.	EAN	Packaging Unit	Minimal Order	Gross Price per piece EURO
Flat forend 132 x 22 x 3 mm	1100000003155	4021226953174	10		

Striking plate for lock for deadbolts and lateral bolts for 603/610/611 series

- For european cylinder frames and two-piece rail frames

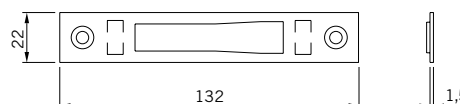

■ Stainless steel

Feature	Order No.	EAN	Packaging Unit	Minimal Order	Gross Price per piece EURO
Flat forend 132 x 22 x 1.5 mm	1100000003156	4021226953198	10		

Striking plate for deadbolts, hook bolts and lateral bolts for 603/610/611 series

- For frames and rail frames



■ Stainless steel

Feature	Order No.	EAN	Packaging Unit	Minimal Order	Gross Price per piece EURO
Flat forend 132 x 20 x 3 mm mm	1100000003157	4021226953211	1		

Striking plate for deadbolt, latch/roller for 603/610/611 series

- For frames and rail frames
- For electric locks with handle

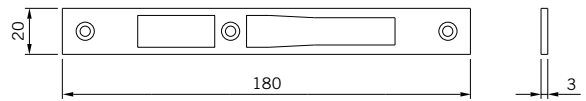

Stainless steel

Feature	Order No.	EAN	Packaging Unit	Minimal Order	Gross Price per piece EURO
Flat forend 180 x 20 x 3 mm	1100000003158	4021226953235	10		

Striking plate for deadbolt, latch/roller for 603/610/611 series

- For frames and rail frames
- For electric locks with handle

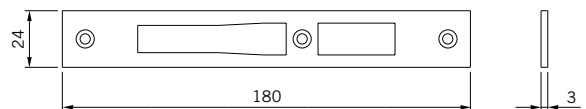

Stainless steel

Feature	Order No.	EAN	Packaging Unit	Minimal Order	Gross Price per piece EURO
Flat forend 180 x 24 x 3 mm	1100000003159	4021226953259	10		

Striking plate for deadbolt, latch/roller for 603/610/611 series

- For frames and rail frames
- For electric locks with handle

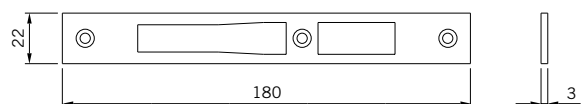

Stainless steel

Feature	Order No.	EAN	Packaging Unit	Minimal Order	Gross Price per piece EURO
Flat forend 180 x 22 x 3 mm	1100000003160	4021226953273	10		

Striking plate for latch and hook bolts for 603/610/611 series

- For european cylinder frames

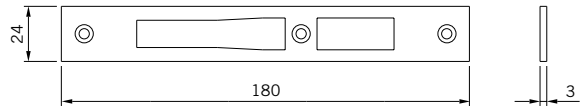

■ Stainless steel

Feature	Order No.	EAN	Packaging Unit	Minimal Order	Gross Price per piece EURO
Flat forend 180 x 24 x 3 mm	1100000003161	4021226953297	10		

Striking plate for deadbolt, latch/roller for 603/610/611 series

- For european cylinder frames and double-bot rail frames
- For electric locks with handle

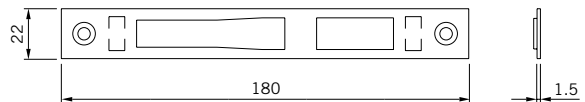

■ Stainless steel

Feature	Order No.	EAN	Packaging Unit	Minimal Order	Gross Price per piece EURO
Flat forend 180 x 22 x 1.5 mm	1100000003162	4021226953310	10		

Striking plate for deadbolt, latch/roller for 603/610/611 series

- For european cylinder frames and double-bot rail frames
- For electric locks with handle

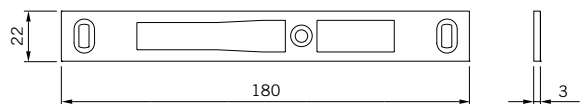

■ Nickel

Feature	Order No.	EAN	Packaging Unit	Minimal Order	Gross Price per piece EURO
Flat forend 180 x 22 x 3 mm	1100000003163	4021226953334	10		

### Striking plate for deadbolt, latch/roller for 603/610/611 series

- For european cylinder frames and double-bot rail frames
- For electric locks with handle

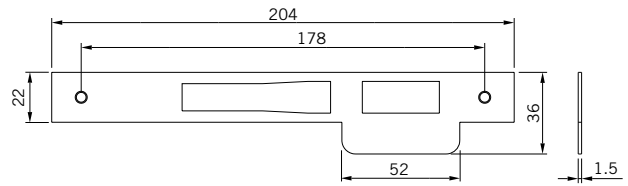

■ Stainless steel

Feature	Order No.	EAN	Packaging Unit	Minimal Order	Gross Price per piece EURO
Flat forend 204 x 22 x 1.5 mm	1100000003164	4021226953358	1		

### Adjustable striking plate for deadbolt and latch for 603/610/611/840 series

- For european cylinder frames
- For locks with deadbolt and latch

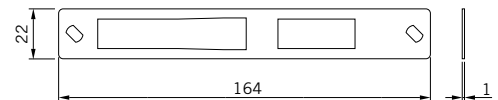

■ Stainless steel

Feature	Order No.	EAN	Packaging Unit	Minimal Order	Gross Price per piece EURO
Flat forend 164 x 22 x 1 mm	1100000003165	4021226953372	10		

### Adjustable striking plate for deadbolt and lateral bolts only for 840 series

- For european cylinder frames and double-bot rail frames
- For locks with deadbolt and lateral locks only

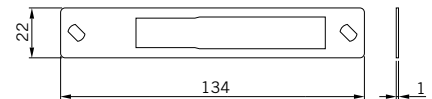

■ Stainless steel

Feature	Order No.	EAN	Packaging Unit	Minimal Order	Gross Price per piece EURO
Flat forend 134 x 22 x 1 mm	1100000003166	4021226953396	10		

Adjustable striking plate for lateral hook bolts only for 840 series

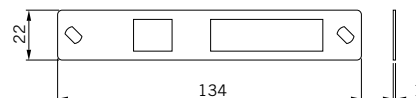

Stainless steel

Feature	Order No.	EAN	Packaging Unit	Minimal Order	Gross Price per piece EURO
Flat forend 134 x 22 x 1 mm	1100000003167	4021226953419	10		

Striking plate for deadbolt and latch only for 604 series

- Striking plate for european cylinder frames
- For locks with deadbolt and latch

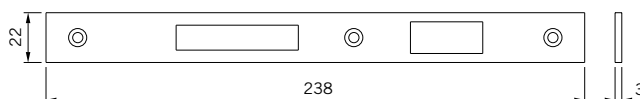

Stainless steel

Feature	Order No.	EAN	Packaging Unit	Minimal Order	Gross Price per piece EURO
Flat forend 238 x 22 x 3 mm	1100000003168	4021226953433	10		
Flat forend 238 x 22 x 3 mm	1100000003169	4021226953457	10		
Flat forend 238 x 22 x 3 mm	1100000003170	4021226953471	10		

Striking plate for deadbolt, latch/roller

- Striking plate for european cylinder frames
- For electric locks with handle

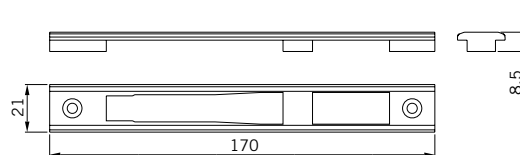

Zamak

Feature	Order No.	EAN	Packaging Unit	Minimal Order	Gross Price per piece EURO
Flat forend 170 x 21 x 8.5 mm	1100000003182	4021226953716	10		



Striking plate for deadbolt, latch/roller for 603/610/611 series

- Striking plate for european cylinder frames
- For electric locks for aluminum frames

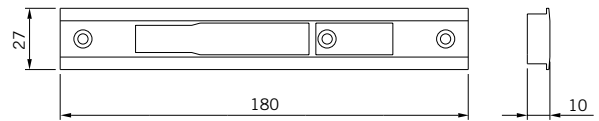

Nylon

Feature	Order No.	EAN	Packaging Unit	Minimal Order	Gross Price per piece EURO
Flat forend 180 x 27 x 10 mm	1100000003171	4021226953495	10		

Striking plate for deadbolt, latch/roller for 603/610/611 series

- Striking plate for european cylinder frames
- For electric locks for aluminum frames

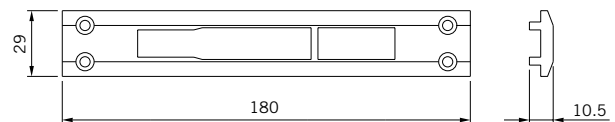

Nylon

Feature	Order No.	EAN	Packaging Unit	Minimal Order	Gross Price per piece EURO
Flat forend 180 x 29 x 10.5 mm	1100000003172	4021226953518	10		

Striking plate for deadbolt, latch/roller for 603/610/611 series

- Striking plate for european cylinder frames
- For electric locks for aluminum frames

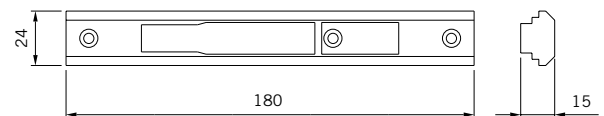

Nylon

Feature	Order No.	EAN	Packaging Unit	Minimal Order	Gross Price per piece EURO
Flat forend 180 x 24 x 15 mm	1100000003268	4021226955437	10		

Striking plate for deadbolt, latch/roller for 603/610/611/840 series

- Striking plate for european cylinder frames
- For electric locks for aluminum frames

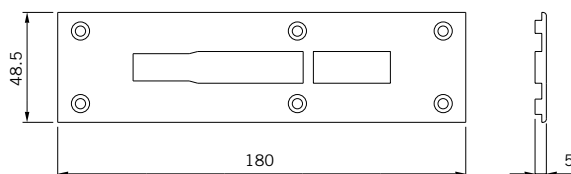

Nylon

Feature	Order No.	EAN	Packaging Unit	Minimal Order	Gross Price per piece EURO
Flat forend 180 x 48.5 x 5 mm	1100000003173	4021226953532	10		

Striking plate for deadbolt, latch/roller for 603/610/611/840 series

- Striking plate for european cylinder frames
- For electric locks for aluminum frames

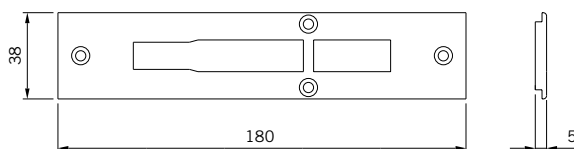

Nylon

Feature	Order No.	EAN	Packaging Unit	Minimal Order	Gross Price per piece EURO
Flat forend 180 x 38 x 5 mm	1100000003174	4021226953556	10		

Striking plate for deadbolt, latch/roller for 603/610/611/840 series

- Striking plate for european cylinder frames
- For electric locks for aluminum frames

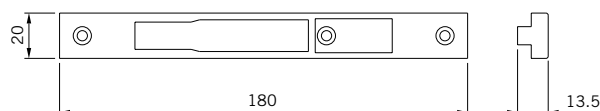

Nylon

Feature	Order No.	EAN	Packaging Unit	Minimal Order	Gross Price per piece EURO
Flat forend 180 x 20 x 13.5 mm	1100000003269	4021226955451	10		

Striking plate for deadbolt, latch/roller for 603/610/611 series

- Striking plate for european cylinder frames
- For electric locks for aluminum frames

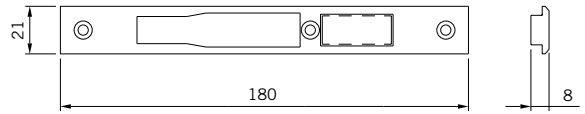

Nylon

Feature	Order No.	EAN	Packaging Unit	Minimal Order	Gross Price per piece EURO
Flat forend 180 x 21 x 8 mm	1100000003175	4021226953570	10		

Striking plate for deadbolt, latch/roller for 603/610/611 series

- Striking plate for european cylinder frames
- For electric locks for aluminum frames

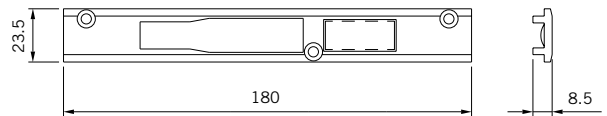

Nylon

Feature	Order No.	EAN	Packaging Unit	Minimal Order	Gross Price per piece EURO
Flat forend 180 x 23.5 x 8.5 mm	1100000003270	4021226955475	10		

Striking plate for deadbolt, latch/roller for 603/610/611/840 series

- Striking plate for european cylinder frames
- For electric locks for aluminum frames

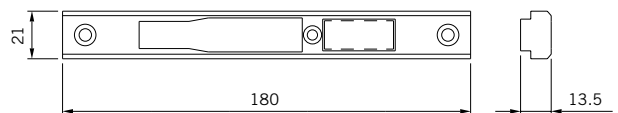

Nylon

Feature	Order No.	EAN	Packaging Unit	Minimal Order	Gross Price per piece EURO
Flat forend 180 x 21 x 13.5 mm	1100000003176	4021226953594	10		

Striking plate for deadbolt, latch/roller for 603/610/611 series

- Striking plate for european cylinder frames
- For electric locks for aluminum frames

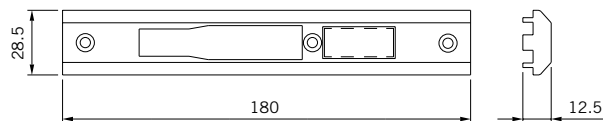

Nylon

Feature	Order No.	EAN	Packaging Unit	Minimal Order	Gross Price per piece EURO
Flat forend 180 x 28.5 x 12.5 mm	1100000003177	4021226953617	10		

Striking plate for deadbolts and lateral bolts only for 603/610/611/840 series

- Striking plate for european cylinder frames
- For aluminum frames

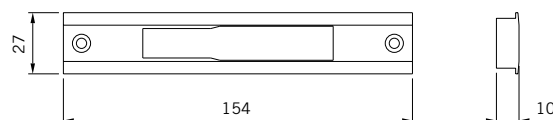

Nylon

Feature	Order No.	EAN	Packaging Unit	Minimal Order	Gross Price per piece EURO
Flat forend 154 x 27 x 10 mm	1100000003178	4021226953631	10		

Striking plate for deadbolts and lateral bolts only for 603/610/611 series

- Striking plate for european cylinder frames
- For aluminum frames

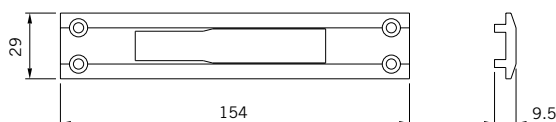

Nylon

Feature	Order No.	EAN	Packaging Unit	Minimal Order	Gross Price per piece EURO
Flat forend 154 x 29 x 9.5 mm	1100000003179	4021226953655	10		

Striking plate for deadbolts and lateral bolts only for 603/610/611 series

- Striking plate for european cylinder frames
- For aluminum frames

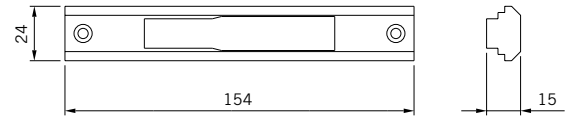

Nylon

Feature	Order No.	EAN	Packaging Unit	Minimal Order	Gross Price per piece EURO
Flat forend 154 x 24 x 15 mm	1100000003272	4021226955512	10		

Striking plate for deadbolt and latch

- Striking plate for european cylinder frames

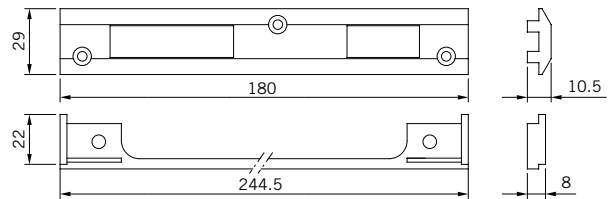

Nylon

Feature	Order No.	EAN	Packaging Unit	Minimal Order	Gross Price per piece EURO
Flat forend 180 x 29 x 10.5 mm					
Flat forend 244.5 x 22 x 8 mm	1100000003180	4021226953679	10		

Striking plate for deadbolt and latch

- Striking plate for european cylinder frames

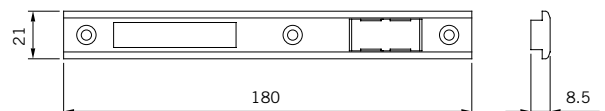

Nylon

Feature	Order No.	EAN	Packaging Unit	Minimal Order	Gross Price per piece EURO
Flat forend 180 x 21 x 8.5 mm	1100000003181	4021226953693	10		

## Forend support

- For european cylinder frames

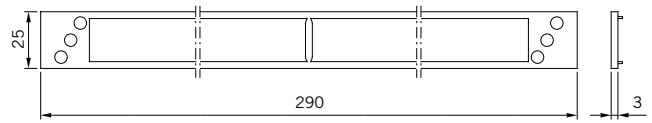

Nylon

Feature	Order No.	EAN	Packaging Unit	Minimal Order	Gross Price per piece EURO
290 x 25 x 3 mm	1100000003183	4021226953730	10		

# ACCESSORIES

## Pair of forend supports spacers

- For europrofile cylinder aluminum frames and two-piece rail frames

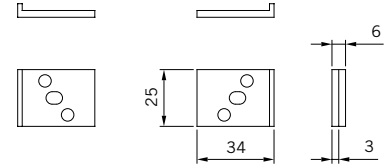

Nylon

Order No.	EAN	Packaging Unit	Minimal Order	Gross Price per piece EURO
1100000003184	4021226953754	10		

## Roller nylon insert for 840 and 610 series

- For adjustable striking plates

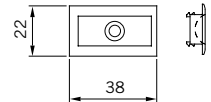

Nylon

Order No.	EAN	Packaging Unit	Minimal Order	Gross Price per piece EURO
1100000003185	4021226953778	10		

## Brass floor socket with anti-dust spring cap for rods

- Inside hole  $\varnothing$  12 mm

Order No.	EAN	Packaging Unit	Minimal Order	Gross Price per piece EURO
1100000003250	4021226955079	10		

## Pair of internal curved rods for 610 and 611 series

- Galvanized tube Ø 8 mm
- For locks with clutch connections

---

 Galvanized steel
 

---

Order No.	EAN	Packaging Unit	Minimal Order	Gross Price per piece EURO
1100000003251	4021226955093	1		

## Pair of internal straight rods for 610 and 611 series

- Galvanized tube Ø 8 mm
- For locks with clutch connections

---

 Galvanized steel
 

---

Order No.	EAN	Packaging Unit	Minimal Order	Gross Price per piece EURO
1100000003252	4021226955116	1		

## D10 rod/tip-guiding upper plate

- Nylon bush

---

 Galvanized steel
 

---

Order No.	EAN	Packaging Unit	Minimal Order	Gross Price per piece EURO
1100000003253	4021226955130	10		



### Kit for internal straight or curved rods with clutch connection for 610 series

- Rods and two tips: Ø 8 mm
- One rod connection
- Two zamak rod guides; two nylon rod guides; two lock fixing plates; one anti-dust floor socket, hole Ø 12 mm

Order No.	EAN	Packaging Unit	Minimal Order	Gross Price per piece EURO
1100000003254	4021226955154	10		

### Kit for external rods for frames with clutch connection for 610 series

- Two external rod-connecting plates; two lock fixing plates, one anti-dust floor socket, hole Ø 12 mm
- Forend with 2 holes

Order No.	EAN	Packaging Unit	Minimal Order	Gross Price per piece EURO
1100000003255	4021226955178	10		

### Threaded connection for rod for 601 and 610 series

- Threaded connection M8 for threaded rod
- To be used with clutch or screwed connection for 3-point locks

Order No.	EAN	Packaging Unit	Minimal Order	Gross Price per piece EURO
1100000002747	4021226945155	20		

### Pair of tips

- Ø 10 mm for M8 threaded rods

Galvanized steel				
Order No.	EAN	Packaging Unit	Minimal Order	Gross Price per piece EURO
1100000003256	4021226955192	10		

### Kit for internal straight rods

- Ø 8 mm for use with M8 threaded connection
- Two carbo-nitrided tips Ø 10 mm; two threaded pins for fixing to connection; two rod guiding plates with nylon bushes

Order No.	EAN	Packaging Unit	Minimal Order	Gross Price per piece EURO
1100000003257	4021226955215	10		

### Pair of plates with pin

- Pair of plates with pin to connect the lock or lateral lock with screwed connections M4 and external rods

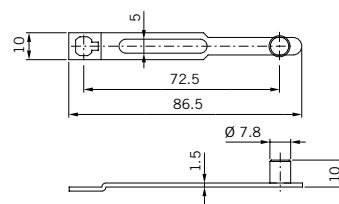

Galvanized steel				
Order No.	EAN	Packaging Unit	Minimal Order	Gross Price per piece EURO
1100000003222	4021226954515	10		

### Kit for internal straight or curved rods

- Ø 8 mm
- Two tips Ø 8 mm; one rod connection; two zamak rod guides; two lock fixing plates

Order No.	EAN	Packaging Unit	Minimal Order	Gross Price per piece EURO
1100000003259	4021226955253	10		

### Pair of internal curved rods for 601 and 610 series

- Zinc plate tube Ø 8 mm with slotted hole for screwed connection M4
- Two tips Ø 8 mm; striker for nylon tip Ø 8 mm
- Two noise-proof nylon bushes; one rod connection; two nylon rod guides; two lock fixing plates
- One anti-dust floor socket hole, Ø 12 mm
- For locks with screwed rod connection

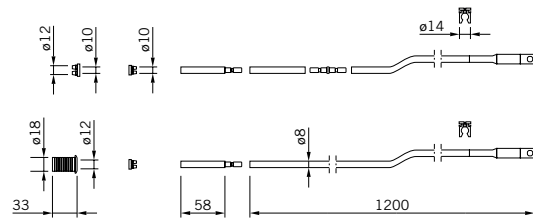

Order No.	EAN	Packaging Unit	Minimal Order	Gross Price per piece EURO
1100000002745	4021226945117	1		

### Pair of internal straight rods for 601 and 610 series

- Zinc plate tube Ø 8 mm with slotted hole for screwed connection M4
- Two tips Ø 8 mm; striker for nylon tip Ø 8 mm
- Two noise-proof nylon bushes; one rod connection; two nylon rod guides; two lock fixing plates
- One anti-dust floor socket, hole Ø 12 mm
- For locks with screwed rod connection

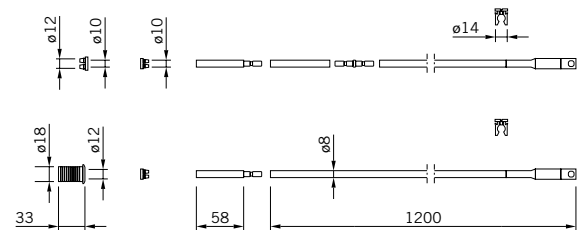

Order No.	EAN	Packaging Unit	Minimal Order	Gross Price per piece EURO
1100000002746	4021226945131	1		



SECURITY WITH  
PREMIUM ACCESS SOLUTIONS  
& SERVICES

# APPENDIX

---

568–571

**Terms and conditions of  
business**  
570–571



**Important information for multipoint locks and mortise locks**

It is important to note the following information relating to locks. Non-compliance with the advice and instructions indicated hereunder will release us from any liability, including manufacturer's liability defined in European product liability law.

**1. Product information and designated use**

A lock usually performs the task of keeping a door secure and locked in its closed position. Many simple lock designs merely serve to secure the door. The term "securing" means keeping a door closed such that it cannot be opened through the application of pull or push forces while at the same time offering ease of opening through the operation of, for example, a lever handle.

"Locking" is understood to mean the retention of the door in its closed position by means of a non-sprung, rigid bolt that is made to project from the door lock and engages in a corresponding recess in the frame or in the strike aperture.

The bolt must be held in its end position, and the opening of the door without a suitable key must be effectively inhibited. The latch serves to keep the door closed when not locked.

The locking operation is thus performed by the bolt. The bolt is ejected by the lock mechanism. The retaining gear (tumbler with anchorage) serves to hold the bolt in a certain defined position. The bolt should only be thrown with the door closed (this also applies to hooklatches/bolts and claw bolts).

Cylinder fixing screws must be adapted to the backset length.

A mortise lock is a lock which is inserted and fixed in a preformed or existing recess, and is used predominantly on swing doors. In order to facilitate correct usage, it is necessary also to ensure the correct combination with permissible fittings and locking devices (e.g. keys, cylinders) plus accessories (e.g. strike plates). Installation must be performed in accordance with the relevant fixing instructions and inline—where appropriate—with harmonized DIN or equivalent standards, with due account also being taken of the maintenance requirements. Locks for doors performing special functions must be selected in accordance with the relevant regulations and, where applicable, carry the appropriate markings for easy identification. In the case of panic and emergency escape locks in doors for emergency exits and escape routes, lever handle operation must not occur simultaneously with the locking or unlocking operation. These locks are designed for a low level of operating frequency restricted to emergencies. The normal, deliberate locking action (i.e. single or double throw by turning the key) or unlocking action must not be replaced by continual operation of the emergency mechanism. Lock-cylinders may only be unconditionally installed in locks if these lock-cylinders are subject to a dimensional standard (e.g. DIN 18254), and where such locks are expressly prepared for lock cylinders in accordance with the same standard.

Essentially, cylinders should be installed such that the locking cam points away from the lock forend, unless the right hand/left hand position of the locking cam has no influence on the night latch position in the lock.

In all other cases, the manufacturer, dealer, installer or user of such locks must be certain that the lock cylinder selected by him is suitable for the installation situation and for the envisaged application. Compliance with legally binding regulations is mandatory. For example, no lock cylinders with a thumbturn, rotary knob or similar handle component may be fitted to panic or emergency escape locks.

General terms, where these are not explained in catalogue sections and illustrations, are defined in DIN 18250, DIN 18251, DIN 18252, DIN 18254 and the hardware standards. Deviations from cited standards must be indicated when ordering.

**2. Misuse**

The misuse—i.e. employment of the product for a purpose other than its designated use—of locks can be said to have occurred if, for example,

- foreign objects and/or items not compliant with the designated use are inserted into the lock, or the strike plate, so preventing effective and functionally correct usage,
- the lock or strike plate are modified, or force is applied to them,

so changing their construction, method of operation or function,

- the projected bolt is used contrary to its designated use in order to hold open the door,
- the lock elements are fitted or subsequently treated—e.g. by painting—such that their function is hindered,
- loads are applied to the lever handle connection that go beyond the designated use and beyond normal manual force
- non-appurtenant—e.g. dimensionally deviant or incorrectly adjusted locking means are used,
- an extension or reduction occurs in the required door gap due to adjustment of the hinges or lowering of the door,
- a double door is opened via the inactive leaf where such manipulation has not been approved,
- body parts are placed between the door leaf and frame when doors are closed,
- simultaneous operation of the lever handle and lock mechanism occurs.

**3. Product performance**

Where product performance data are not specifically indicated in our catalogues, brochures, performance descriptions, etc., the requirements for the individual locks must be agreed upon with us. The standards DIN 18250, DIN 18251, DIN 18252, DIN 18254, DIN 18257, DIN 18258 and EN 12209.

These standards specify both the basic and additional requirements that locks are required to satisfy. The content of the standards may also be applied analogously to other locks. The fitness for purpose of locks is dependent, inter alia, on frequency of use, methods of operation, environmental influences and the level of care and maintenance applied.

Notwithstanding correct lubrication, lock cylinders and keys must be replaced as soon as malfunctions begin to occur on insertion and removal of the key.

**4. Product maintenance**

Locks must be lubricated at least once a year or—depending on frequency of use—more often—employing a recommended lubricant. The correct fit of, for example, cylinders, door furniture and other hardware should also be checked and ensured as part of the maintenance routine.

Only those cleaning agents should be used which contain no corrosion-promoting constituents.

**5. Duty to inform and instruct**

In order to fulfil the duties to inform and instruct in accordance with European product liability law, we urge specialist dealers, locksmiths, architects, specifiers, installers, fabricators and users to avail themselves of the following documents and services, all of which are available on application:

- catalogues, brochures
- specification texts, quotation documentation, lock drawings
- DIN 18250, DIN 18251, DIN 18252, DIN 18254, DIN 18257, DIN 18258 (exclusively distributed by Beuth Verlag GmbH, Berlin 30)
- installation, operating and maintenance instructions
- advice from us, our agents and representatives and our field service personnel.

For the selection of locks and their installation, operation and maintenance,

- architects and specifiers are required to request from us all the necessary product information and to comply with its content,
- specialist dealers are required to observe the requirements indicated in the product information documents and advisory notes in the price lists, and particularly to request from us all the necessary instruction sheets/manuals and pass these on to fabricators, installers and users,
- fabricators and installers are required to observe the requirements indicated in all items of product information, and in particular to request from us operating and maintenance instructions, and to pass these on to their clients and users.

### Important information for cylinders

It is important to note the following information related to cylinders for mechanical locks. Non-compliance with the advice and instructions indicated hereunder will release DORMA from any liability, including manufacturer's liability defined in European product liability law.

#### 1. Product information and designated use

A cylinder for mechanical locks is usually installed into locks, fittings, appliances, doors or related products, which have been prepared for this purpose. It is in general an easily exchangeable component. For regular operation a cylinder for locks is assigned a minimum of one key. Technical terms related to cylinders for locks and Master-Key-Systems are defined and illustrated in this catalogue or within the standard DIN 18 252/DIN EN 1303.

Referring to the DIN/EN1303 the following items have to be considered:

- Cylinders for locks can be installed into locks, fittings, instruments and other applications only, if those cylinders for Locks are manufactured according the dimensional requirements of standards (e. g. DIN 18 252 – 12.06/DIN EN 1303 04.05 for profile cylinders) and if those locks, fittings or instruments have been manufactured to be used with cylinders for Locks especially according to these standards. In all other cases the manufacturer, dealer, installer or user of such locks, fittings, instruments etc. has to make sure that the chosen locking cylinder fits for its installation and for its designated purpose. Binding legal regulations have to be taken into consideration. Special applications, like panic locks are not allowed to use cylinders with knobs, turning knobs or similar handles and require special cams, which are not blocking the lock.
- Cylinders for locks which might be subject to vandalism are not allowed to protrude over a maximum of 3 mm from the tightly fitted protective surface. The degree of anti burglary measures depends on the requirements of the application. (e. g. given by DIN 18 252 – 12.06/DIN EN 1303 04.05 for profile cylinders)
- The installation of cylinders for locks has to assure that no external forces besides the designated mounting points and by regular operation is exerted on the locking cylinder. Likewise no outside force may be transmitted onto the cam toe or in the direction of the locking lever turning.
- For applications like fridge rooms or high humidity environment, direct weather exposure, sea water or aggressive, highly corrosive ambience special customized cylinders have to be specified. The same fact applies to cylinders for locks which are to be used in particularly dusty environments.
- Normally a profile cylinder with two operating ends cannot be operated with a key, when another key has been inserted from the other end. If this function is required an appropriate 'emergency function'-cylinder must be selected.
- To use a key properly, the torque must be transmitted to the key only, when the key has been fully inserted into the key channel of the locking cylinder.
- Cylinder for locks and the related key are one operating unit. Our warranty applies exclusively to our original DORMA products.
- All keys delivered later on request or reproduced have to be tested with the corresponding locking cylinder immediately after delivery.

#### 2. Misuse

The misuse – i.e. employment of the product for a purpose other than its designated use – of Cylinders for Locks can be said to have occurred if, for example:

- the torque is increased by use of tools like nails, pliers, key-ring or others to the neck of the key or its head. In the interest of locking

safety, the key barrel and correspondingly the key shaft are deliberately designed so narrow, that the torque can only be transmitted to the head of the key by hand;

- keys are used as handles to move the doors. Keys are not suitable to replace fittings of doors (knobs, handles, etc.);
- Cylinders for Locks are operated with bent or damaged keys;
- attempts are made to operate the locking cylinders with locking tools, devices or master keys not supplied by the producer;
- foreign bodies are located inside the key barrel, or, for that matter, are attached to the key or whenever maintenance instructions are not observed.

#### 3. Product performance

In case of missing product specification or features, which are not described in detail in our catalogues, leaflets or performance descriptions, requirements for individual locking cylinders should be mutually agreed. Orientation is giving by the product standards DIN 18 252 – 12/2006 - Profile cylinders for door locks – Terminology, dimensions, requirements and marking - as well as by DIN EN 1303 – 04/2005 - Cylinders for locks - .

These standards determine basic and additional requirements for profile cylinders with single row pin followers. The contents of the related standards has also to be applied to other types of locking cylinders. The serviceability of Cylinders for locks depends, beside other items, on frequency of use, method of use, environmental influences and maintenance. Cylinders for Locks and keys should be replaced as soon as difficulties are arising, particularly when inserting or extracting the key, even when the locks has been greased according to instructions.

#### 4. Product maintenance

Cylinders for Locks have to be greased at least twice every year – or more frequently, depending on frequency of use, with the lubricant recommended by DORMA. Basically, Cylinders for locks should never be lubricated with oil. Please use only cleaning substances which contain no corrosion stimulating elements.

#### 5. Duty to inform and instruct

For the fulfilments of their information and instruction obligation according to the product liability law, the following documents and services are available for specialized dealers, locksmiths, architects, designers, security planners, installers and end users:

- catalogues, leaflets, brochures, Web pages, E-Learning tools
- tender information, quotation documents, key assignment plans
- DIN 18 252/DIN EN 1303 (exclusive sales by Beuth Verlag GmbH, Berlin)
- instructions for installation, operation and maintenance
- advice by DORMA and our field service.

Regarding selection of Cylinders for locks, as well as installation, operation and maintenance of cylinders please secure that:

- specialized dealers are obliged to observe product information and instructions contained in the price lists and particularly, to request all necessary
- instruction leaflets from us and to forward them to installers or users;
- installers are obliged to observe all product information, and particularly, to request operation and maintenance instructions from us and to forward them to customers and end users;
- architects, designers, and advisory institutions are obliged to request all necessary product information from us and to observe it.

